

FUN WITH

F O O D



**A NUTRITION EDUCATION PACKAGE FOR PRESCHOOLS
THIRD EDITION**

In partnership with:



CONTENT

	Page
Foreword _____	1
Introduction _____	2
Chapter 1 My Healthy Plate _____	3
Chapter 2 Vegetables _____	15
Chapter 3 Fruits _____	22
Chapter 4 Wholegrains _____	27
Chapter 5 Milk _____	33
Chapter 6 Beans _____	43
Chapter 7 Fish & Meat _____	53
Chapter 8 Healthier Choices _____	62
Chapter 9 Water _____	69
Note to Parents _____	80



FOREWORD

We make choices about the food we eat and our lifestyles everyday. Establishing healthy eating habits from young and sustaining such habits through to adulthood is critical – studies show that the dietary habits of children are formed well before the age of five.

Parents and teachers play an important role in inculcating healthy eating habits in young children. Some approaches at home may include:

- i) Offering a variety of healthy foods and snacks regardless of preference;
- ii) Regularly trying new foods;
- iii) Ensuring variety to keep meals interesting and flavourful;
- iv) Involving children in the process of meal-planning (e.g. through simple tasks such as creating and decorating a menu);
- v) Having regular family meals. Eating meals together as a family also encourages good eating habits alongside family bonding.

In this book, children get to learn about different types of foods and their nutrition. Through suggested activities such as using 'My Healthy Plate', children also learn to make better food choices by themselves.

We hope you would enjoy using these resources to enrich the children's learning journey and we thank the Health Promotion Board (HPB) for providing the resources to support the children's holistic development through an integrated approach.

Chua Lay Mui
ECDA Fellow
Executive Principal
PCF Sparkletots

The best time to inculcate healthy habits in an individual is during their childhood years. A child who builds healthy habits from young is more likely to keep these habits in adulthood. Children largely adopt and build their habits through modelling their parents' habits, such as eating a variety of healthy foods and keeping an active lifestyle.

Early Childhood educators play an imperative role in shaping the healthy habits of children. In our early year's centres, HPB has implemented the Healthy Meals in Pre-Schools Programme (HMPP), which includes guidelines for healthy meals served in pre-schools. This resource book provides an extension to the HMPP by providing activity ideas for educators.

Parents can also benefit from resource book activities such as 'Planning Healthy Snacks'. At home, parents are encouraged to continue modelling good healthy habits for their children, beginning with having a balanced diet during mealtimes at home.

It is our hope that parents and teachers alike will find this resource book useful in helping to develop healthy habits in children.

Suhana Binte Salleh
ECDA Fellow
Cluster Quality Manager
My First Skool

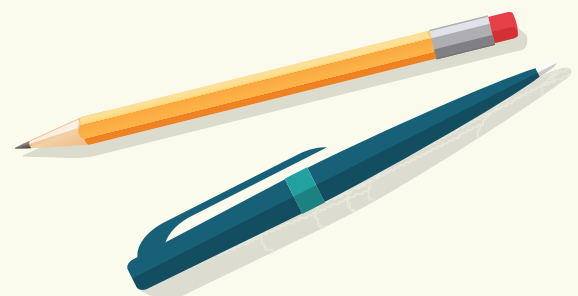

INTRODUCTION

Obesity is a leading public health concern which could lead to diseases such as type 2 diabetes and hypertension. Beyond its health impact, obesity may also negatively impact school performance, school attendance, and general well-being.

Obesity could set in as early as age of five. The popular belief that children will outgrow their 'baby fat' is largely untrue. Alarming, local data shows that seven in ten children who are overweight at age seven will remain that way well into their adult years. Therefore, it is important to educate children on healthy eating and lead them on a healthful journey that will improve their quality of life.

Singaporeans and obesity

Overweight sets in during early childhood.



10% of five-years-olds are overweight.



70%

of children who were overweight at age seven stayed overweight as adults.

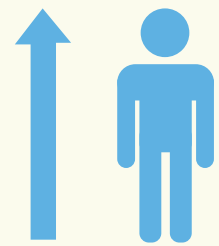

Obesity in Singapore is projected to hit **15%** by 2024 if nothing is done. Currently, it is 11%.



Weight increase of Singaporeans, on average, compared to a decade ago.

The 11- to 12-year-olds today are more likely to be **obese or severely obese**, compared to 20 years ago.

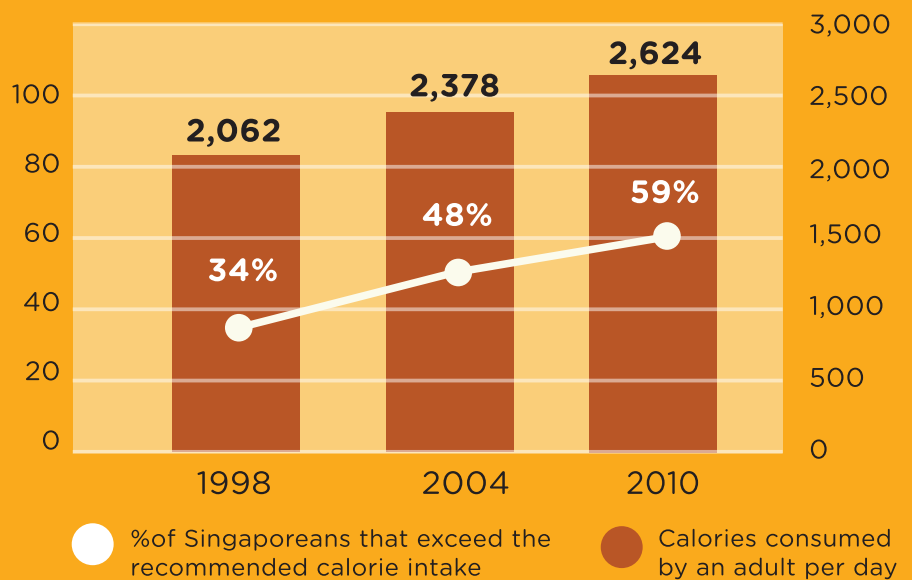

Good nutrition forms the foundation for healthy eating habits that will follow children into their adulthood. Fun with Food (Third edition) contains activity cards that are available in 3 levels, ranging from simple to complex and designed to familiarise children with the different types of food available in Singapore - thereby also nurturing an interest in healthier eating from a young age.

MY HEALTHY PLATE

Lesson Objectives

For children to use My Healthy Plate as a visual guide for a balanced meal.

Background Information

- **How many types of food do you know?**

In multicultural Singapore, there are many types of delicious food from different cultures. From the moment we are born, we begin to learn about food using all our senses.

- **Why do we need to eat?**

We need to eat because food gives us the nutrients and energy to grow and develop. With all the food to choose from daily, we need to learn to make the right choices that will provide us with good nutrition, not just good taste.

We should enjoy a wide variety of food, taken in moderation and in the right balance.

- **What is My Healthy Plate?**

My Healthy Plate is a friendly and easy guide to help us create balanced and healthy meals.

As the plate indicates, we should fill half our plate with fruit and vegetables; a quarter with wholegrain foods such as brown rice and wholemeal bread; and the remaining quarter with protein-rich food such as meat. Eating a balanced meal ensures that we get all the nutrients we need.



ACTIVITIES

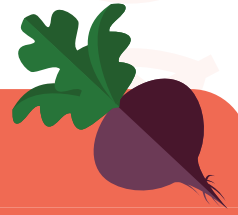

Activity 1

Cut out the items in the Food Cards and place onto My Healthy Plate template to create a balanced meal. Children can use their creativity to color in the food images and My Healthy Plate.



Activity 2

Cut out the food cards for patterning activities (food cards are placed onto the food tray).

Activity 3



Get the children to look, think and compare about components of a balanced meal:

Rice

- Look at the two different types of rice (white, brown)
- Think and discuss what are the differences between the two types of rice
- Compare with the type of rice you eat at home

Carrots

- Look at the different ways the carrots are prepared (whole, cut to round, shredded)
- Think and discuss how the different items are made
- Compare with the carrot dishes you eat at home

Chicken

- Look at the different ways the chicken is prepared (whole, chicken breast, meatballs)
- Think and discuss how the different items are made
- Compare with the chicken dishes you eat at home

Apple

- Look at the different ways the apples are prepared (whole, sliced, cut to chunks)
- Think and discuss how the different items are made
- Compare with the apple that you eat at home

Finally, draw the different types of food on a My Healthy Plate to form a balanced meal.

FOOD CARDS

Cut out the items in the Food Cards and place onto My Healthy Plate template to create a balanced meal. Children can use their creativity to color in the food images and My Healthy Plate.

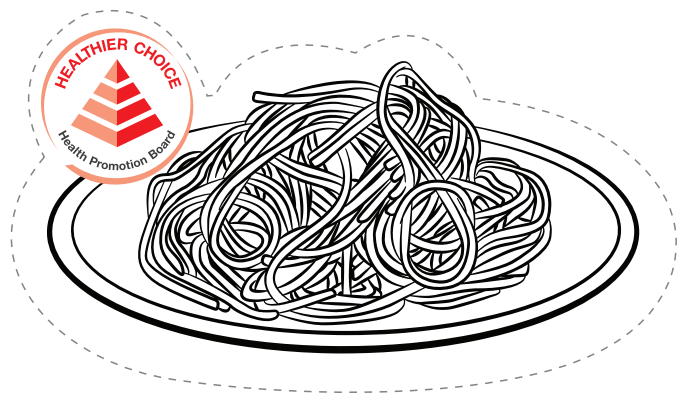
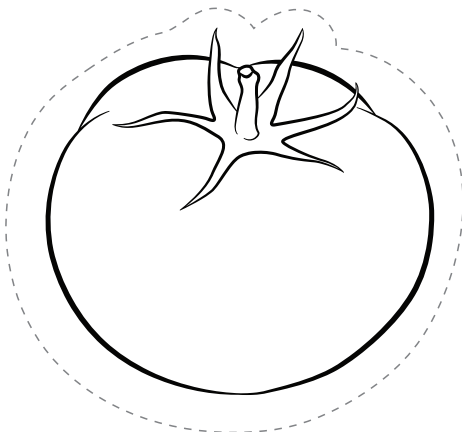
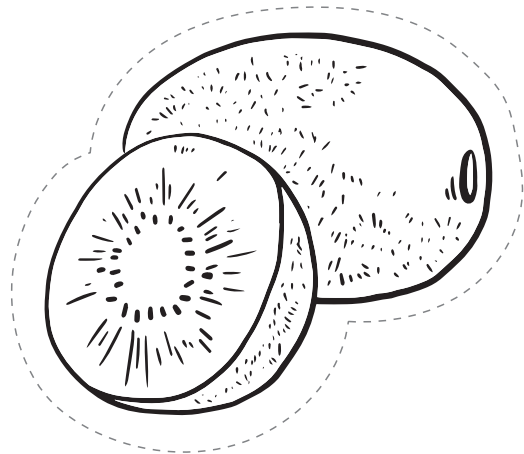
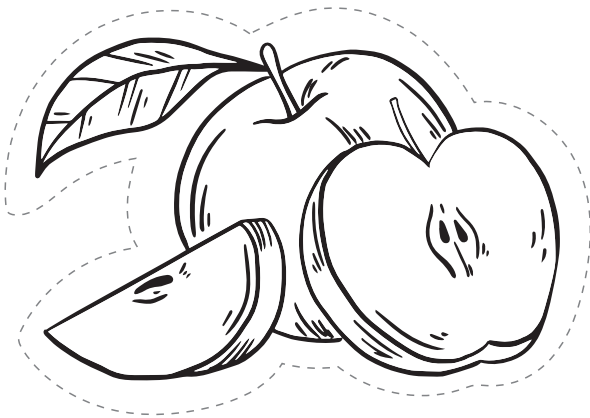
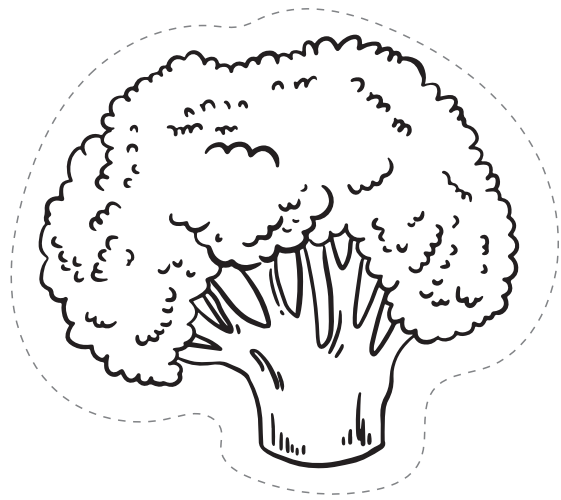

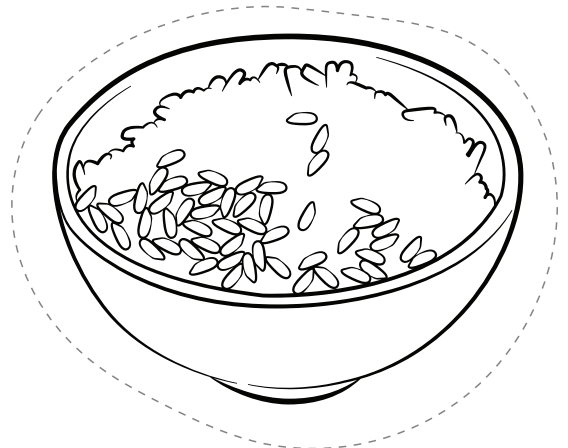
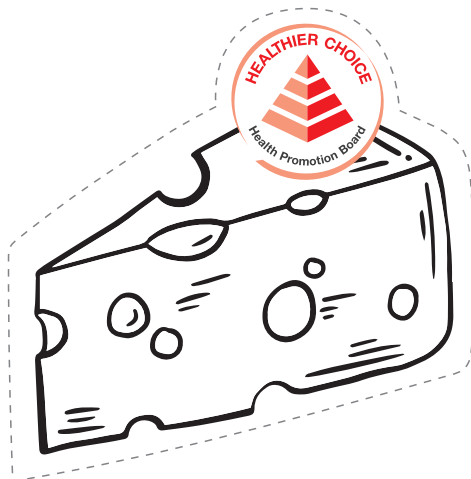
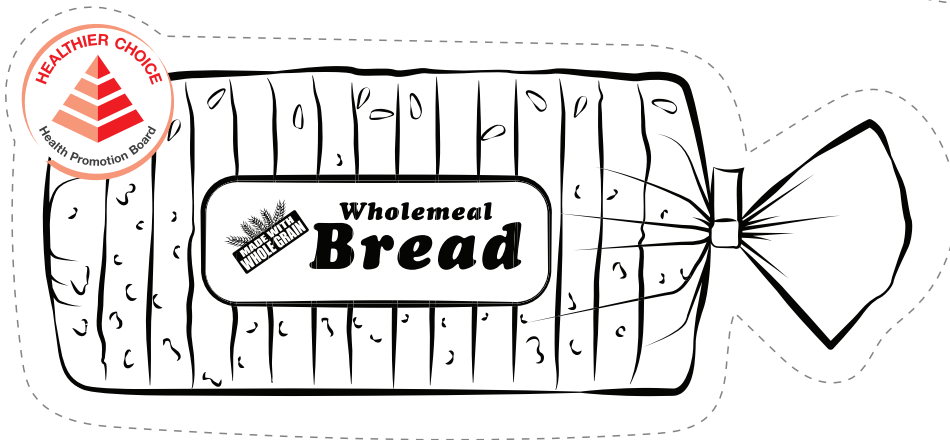
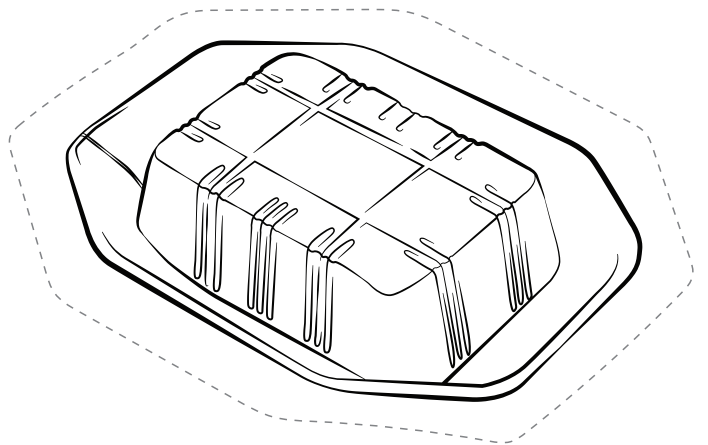
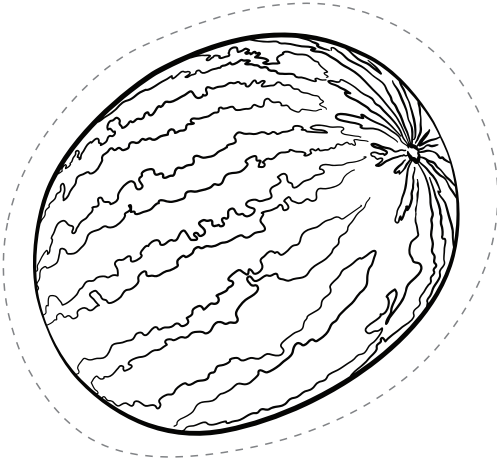
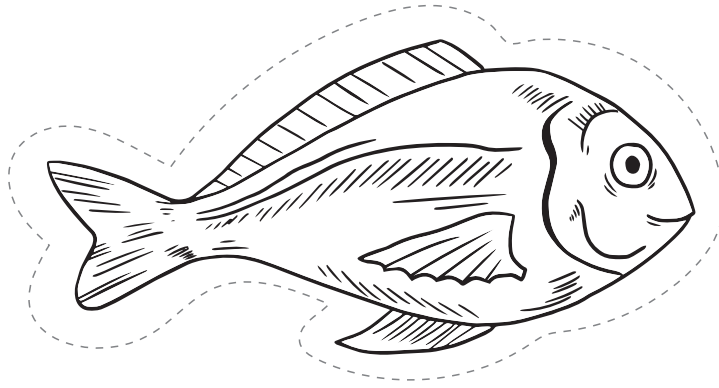

Name: _____

Class: _____

Date: _____

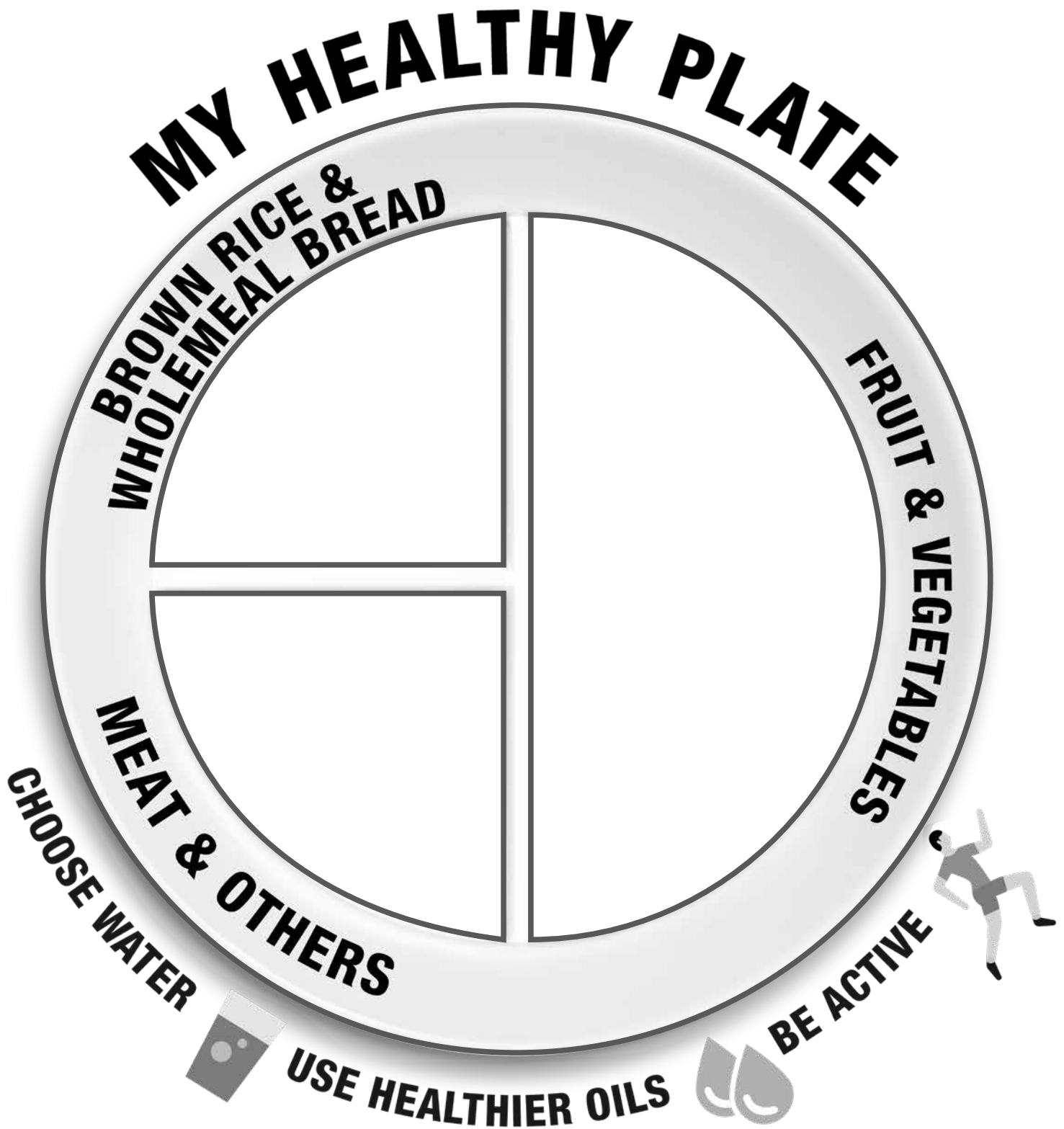

FOOD CARDS

Cut out the food cards for pattering activities (food cards are placed onto food tray).

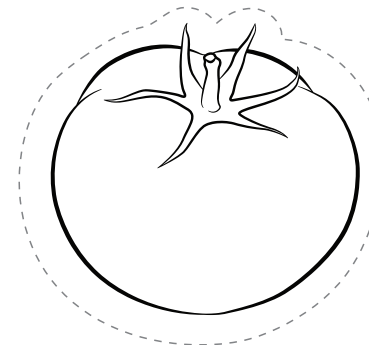
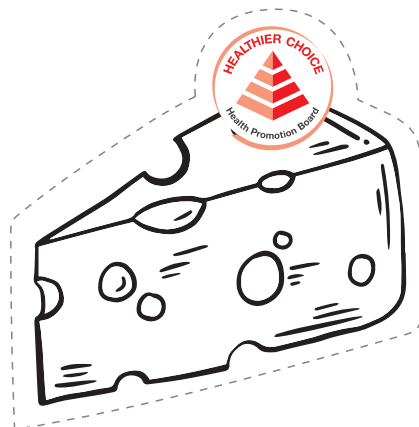
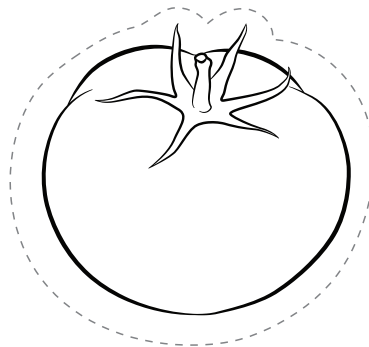
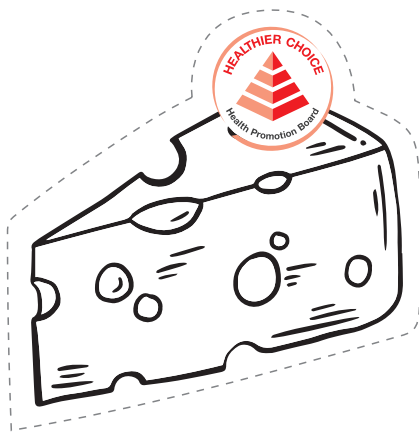
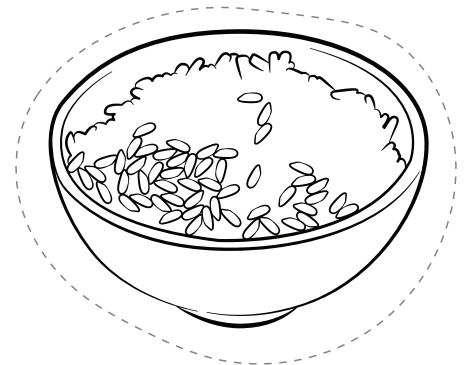
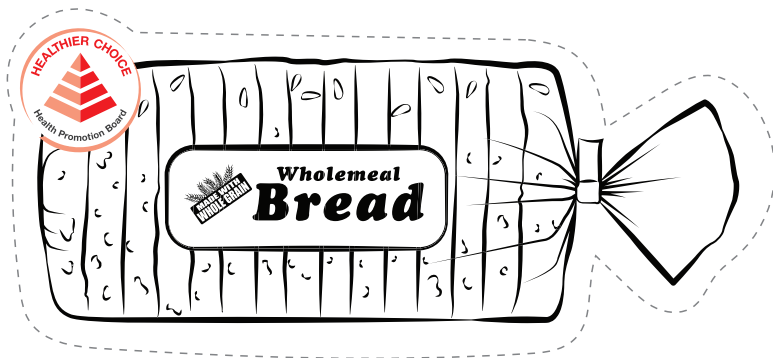
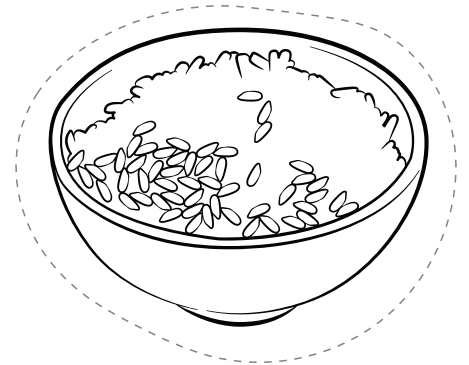
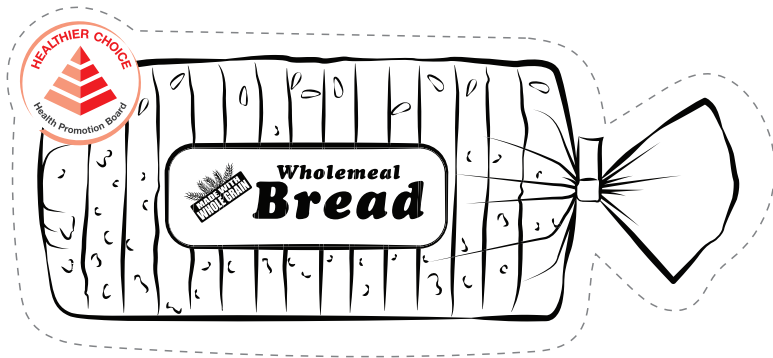

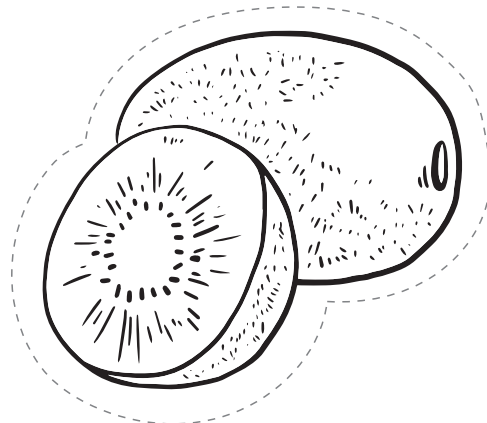
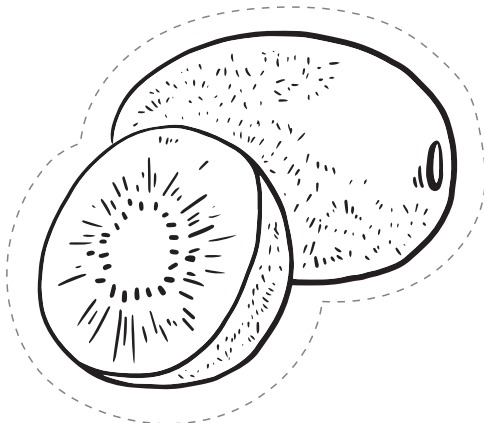
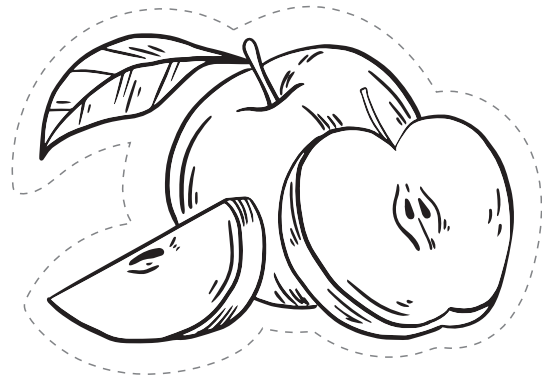
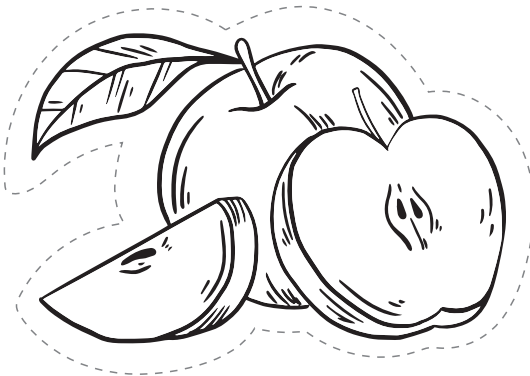
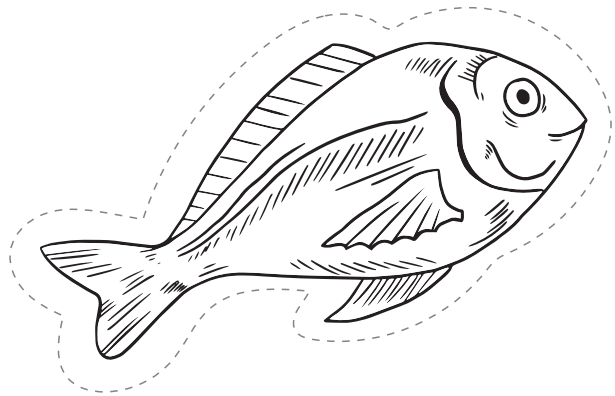
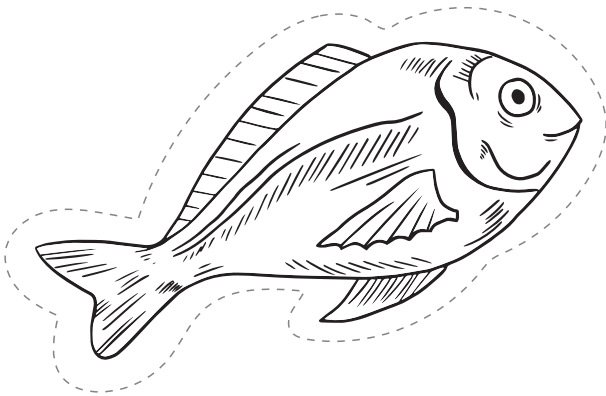
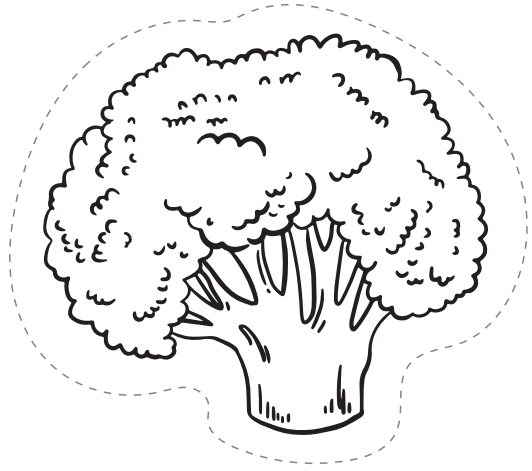
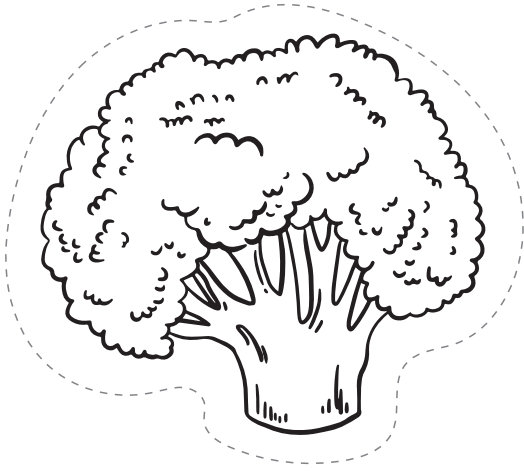

Name: _____

Class: _____

Date: _____

Place food cards onto food tray.

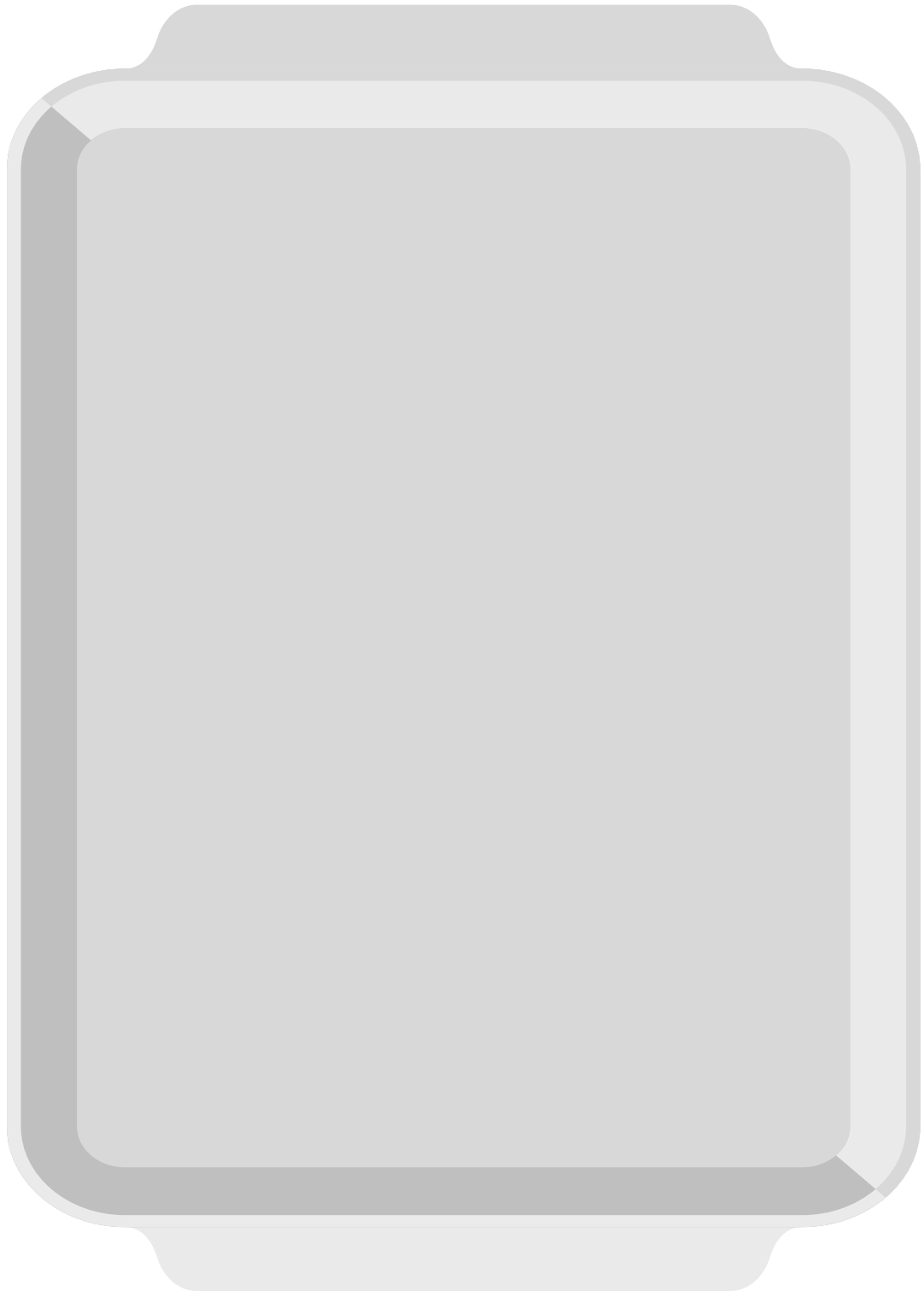

Get the students to look, think and compare about components of a balanced meal:

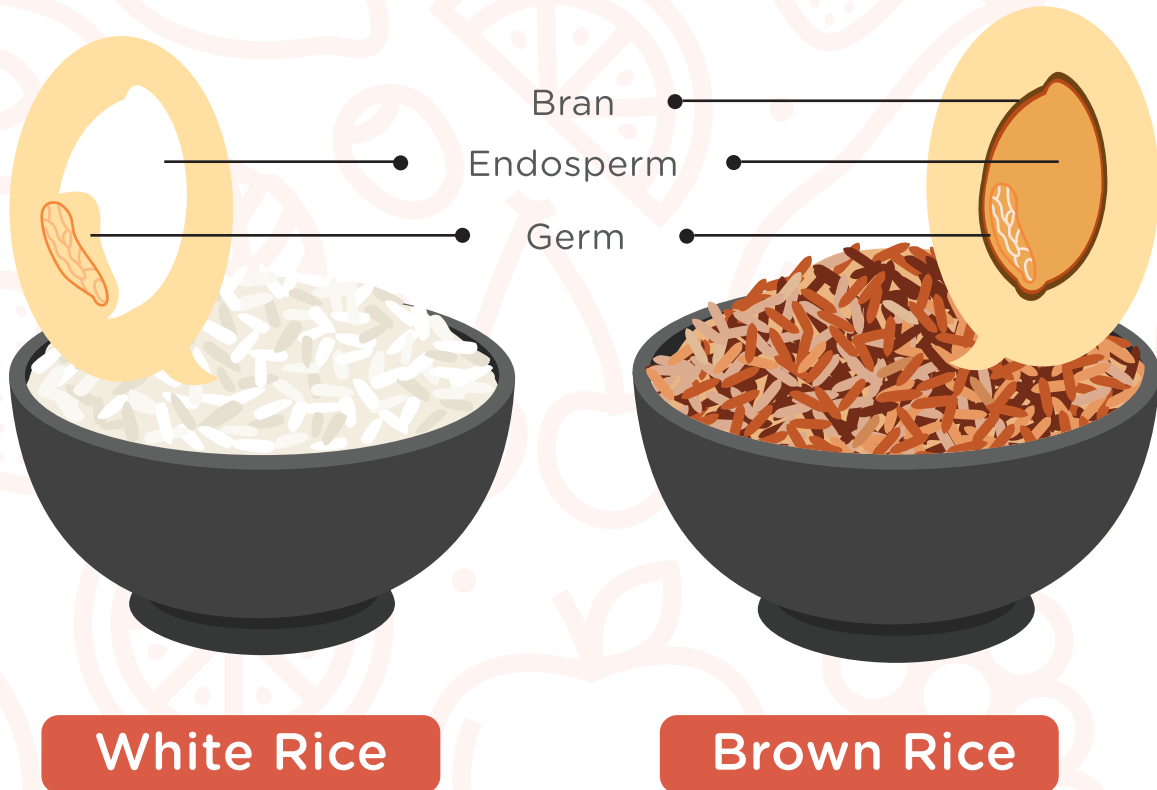

Rice

Look at the two different types of rice

Think and discuss what are the differences between the two types of rice

Compare with the type of rice you eat at home

Get the students to look, think and compare about components of a balanced meal:

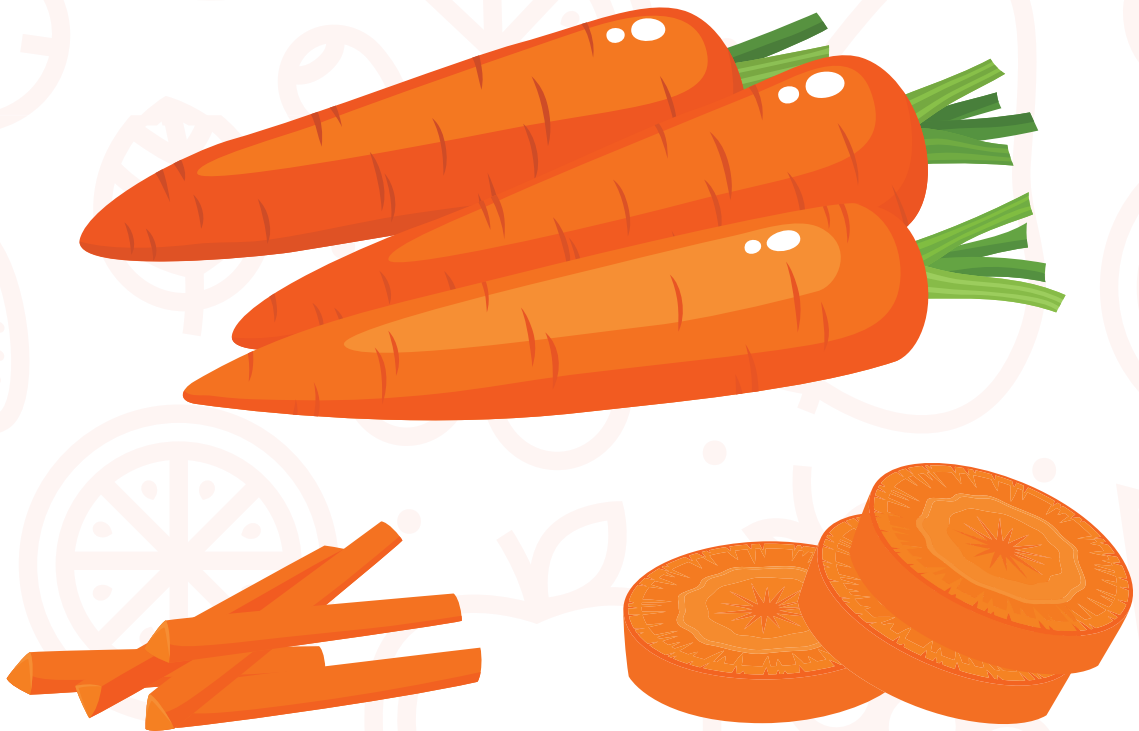

Carrots

Look at the different ways the carrots are prepared (whole, cut to round, shredded)

Think and discuss how the different items are made

Compare with the carrot dishes you eat at home

Get the students to look, think and compare about components of a balanced meal:

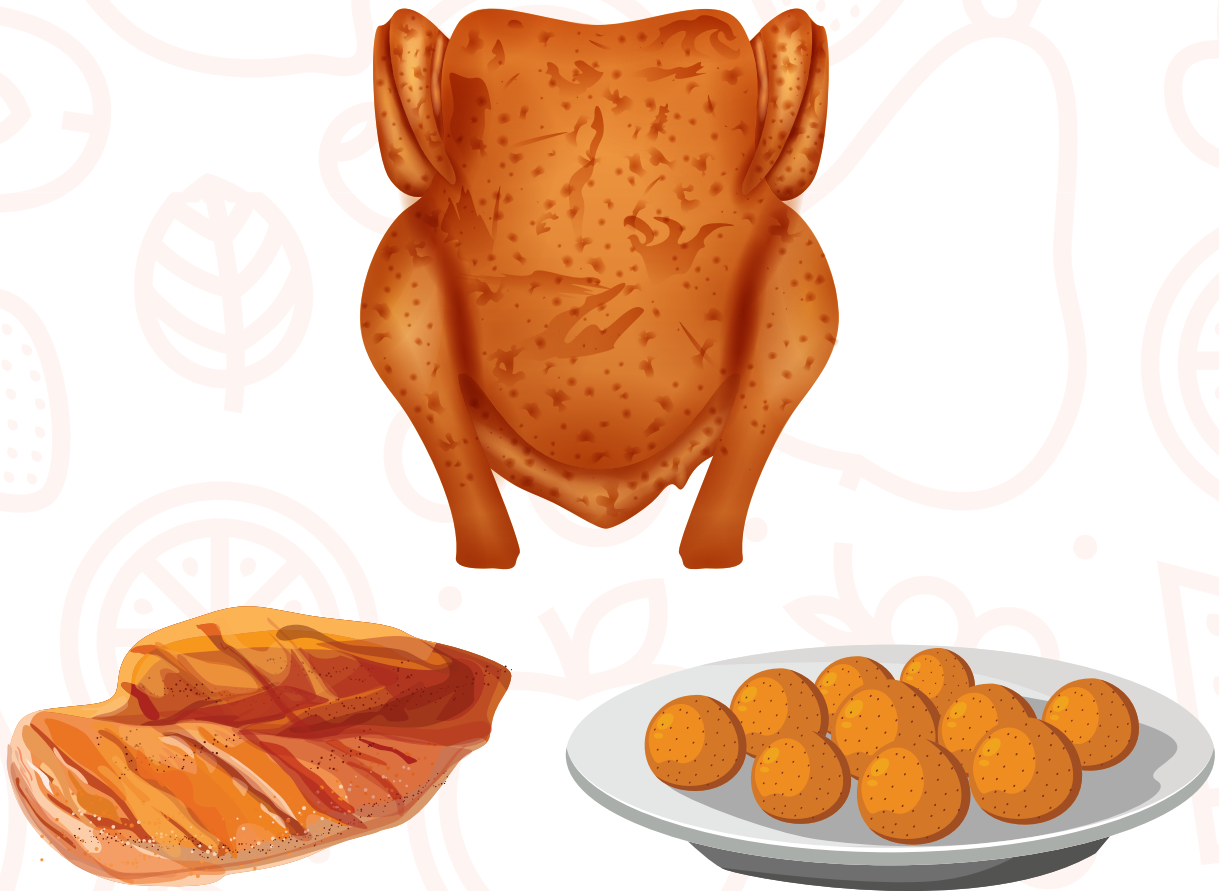

Chicken

Look at the different ways the chicken is prepared (whole, chicken breast, meatballs)

Think and discuss how the different items are made

Compare with the chicken dishes you eat at home

Get the students to look, think and compare about components of a balanced meal:

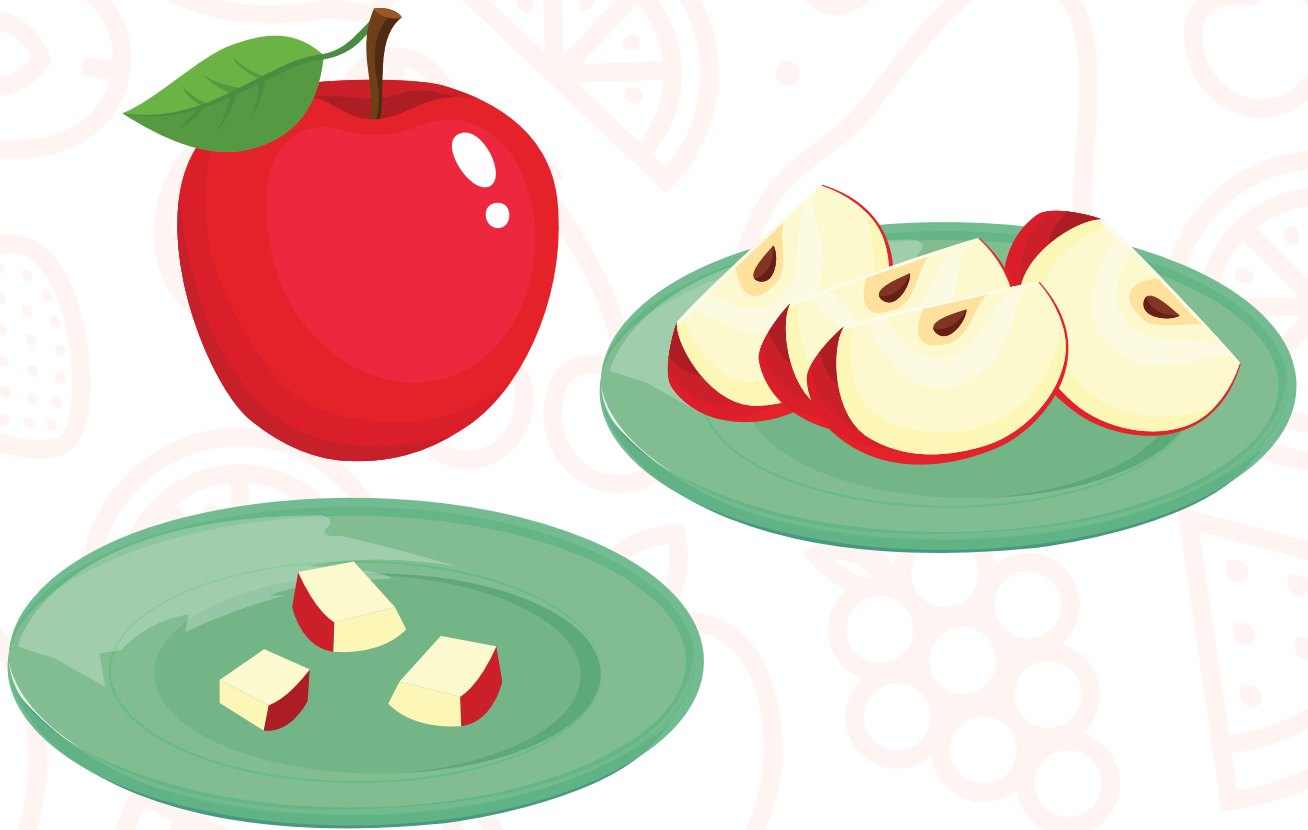

Apple

Look at the different ways the apples are prepared (whole, sliced, cut to chunks)

Think and discuss how the different items are made

Compare with the apple that you eat at home

VEGETABLES

Lesson Objectives

For children to appreciate eating vegetables.

Background Information

- **We all know that we should be eating vegetables. But the truth is, most of us are not eating enough of them. Vegetables are crucial to our diet as they're a source of vitamins and minerals, which are important nutrients for a child's growth. Vegetables also contain dietary fibre, which provides bulk in the diet to help us feel full.**
- **Vegetables are parts of plants. They can be the root, stem, leaf, flower, seed or fruit of the plant.**
 - **Root vegetables** grow underground. Common root vegetables include potatoes, carrots and radishes.
 - **Stems** are the part of the plant between the root and the leaves. Some examples of vegetables that are stems are celery and asparagus.
- **Leafy vegetables** are the leafy parts of the plant that we eat. Examples include cabbage, lettuce, spinach and watercress.
- **Flowers** that we eat as vegetables include cauliflower and broccoli.
- **Seeds** are often held in pods, like in snow peas, long beans and French beans. Some mature beans, like soya beans and green (mung) beans, can be sprouted and eaten as bean sprouts.
- **Fruits** of the plant that we typically consider to be vegetables include eggplant (brinjal), green and red peppers (capsicum), tomato, cucumber and bittergourd.

Did you know?

Some vegetables like celery, cucumber and lettuce can be eaten raw while others like carrots, asparagus, tomatoes and spinach release antioxidants and vitamins when cooked.

- **Vegetables as part of a balanced diet**

We should aim to eat 2 servings of fruit and 2 servings of vegetables each day. Vegetables like potatoes and corn do not count towards the 2+2 servings as they are high in starch and come under the same category as starchy carbohydrates such as rice or bread.

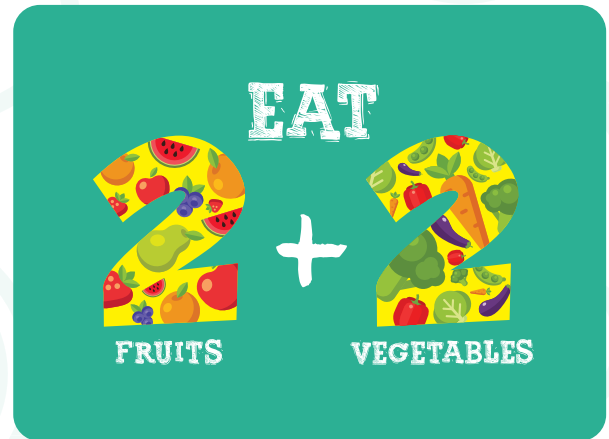

- **Eating a rainbow of vegetables**

Notice how all of the different vegetables form a colourful spectrum, like the rainbow? The different colours of fruits and vegetables indicate the different nutrients they contain. To enjoy the benefits of all these nutrients, we should eat a variety of different vegetables.

- **Dark coloured and green leafy vegetables** such as broccoli, spinach, cabbage and lettuce are rich in vitamins A, B7, B9 and minerals such as Potassium and Folate.
- **Red fruits and vegetables** contain Lycopene, which is good for the heart
- **Orange and yellow fruits** are rich in Carotenoids, Potassium, and Vitamin C to boost your immunity

- **Blue and purple fruits** and vegetables contain Anthocyanin, an antioxidant that helps to support healthy blood pressure
- **Green fruits** are rich in calcium to help strengthen your teeth and bones

In a recent study that was conducted by the Health Promotion Board, we found that these vegetables are especially popular among children aged seven to sixteen:

- | | | | |
|------------|-----------|-----------|---------------|
| • Broccoli | • Spinach | • Lettuce | • Cauliflower |
| • Carrots | • Cabbage | • Corn | • Kangkong |

ACTIVITIES

Activity 1

Option A

Get the children to match (find) the other half of the vegetable.

Option B

Get the children to match the images of the vegetables to the correct corresponding names.



Activity 2



Cut out the strips and arrange them in the right sequence to make vegetable soup.

Activity 3



Get children to observe, think about, and draw different types of vegetables.

- Go for a walk in a community garden and show children the different types of vegetables.
- Think about the knowledge and materials required to setup the garden.
- Draw out their own vegetable gardens.

Name: _____

Class: _____

Date: _____

Option A

Find the other half of the vegetable.

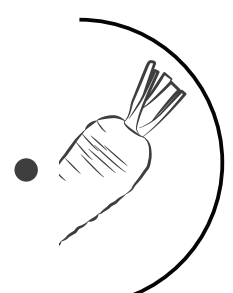
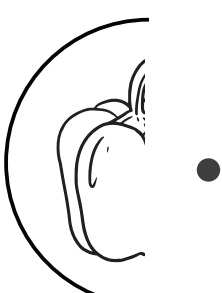
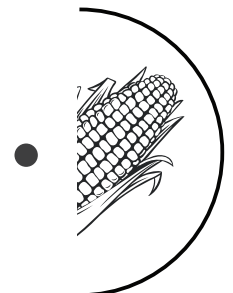
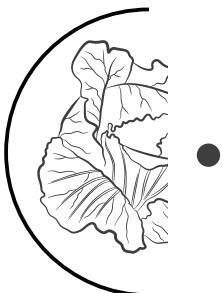
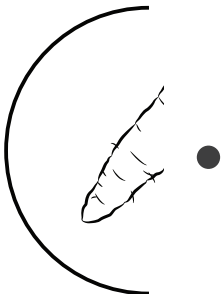
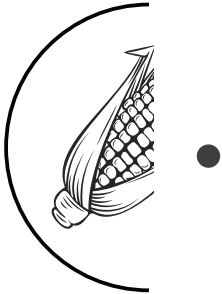
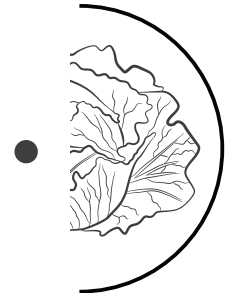

Name: _____

Class: _____

Date: _____

Option B

Match the vegetables to the correct names.



●

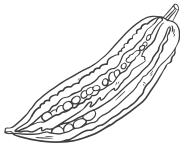

●



●



●



●

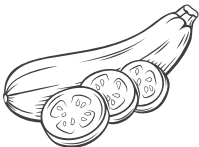

●



●



●

- Broccoli
- Red Capsicum
- Lady's Finger
- Bittergourd
- Eggplant
- Spinach
- Asparagus
- Zucchini

Cut out the strips and arrange them in the right sequence to make vegetable soup.

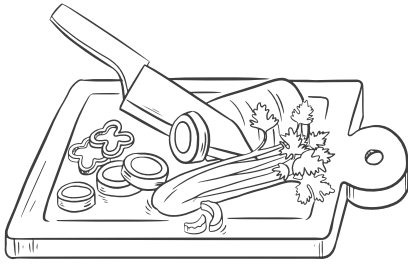

Chop the vegetables.

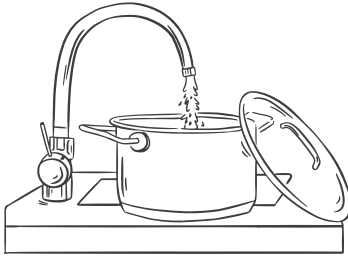

Fill the pot with water.



Boil the water in the pot.

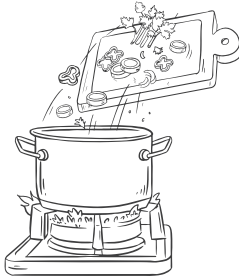

Add the chopped vegetables into the pot.

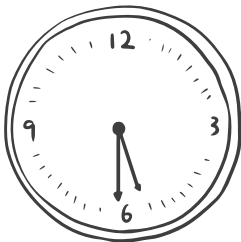

Boil the soup.

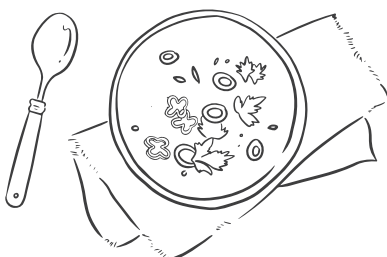

The vegetable soup is ready to be served!

Name: _____

Class: _____

Date: _____

Create your own vegetable garden.

- Go for a walk in the community garden and observe the different types of vegetables.
- Think about the steps and materials required to setup a garden.
- Draw your own vegetable garden.

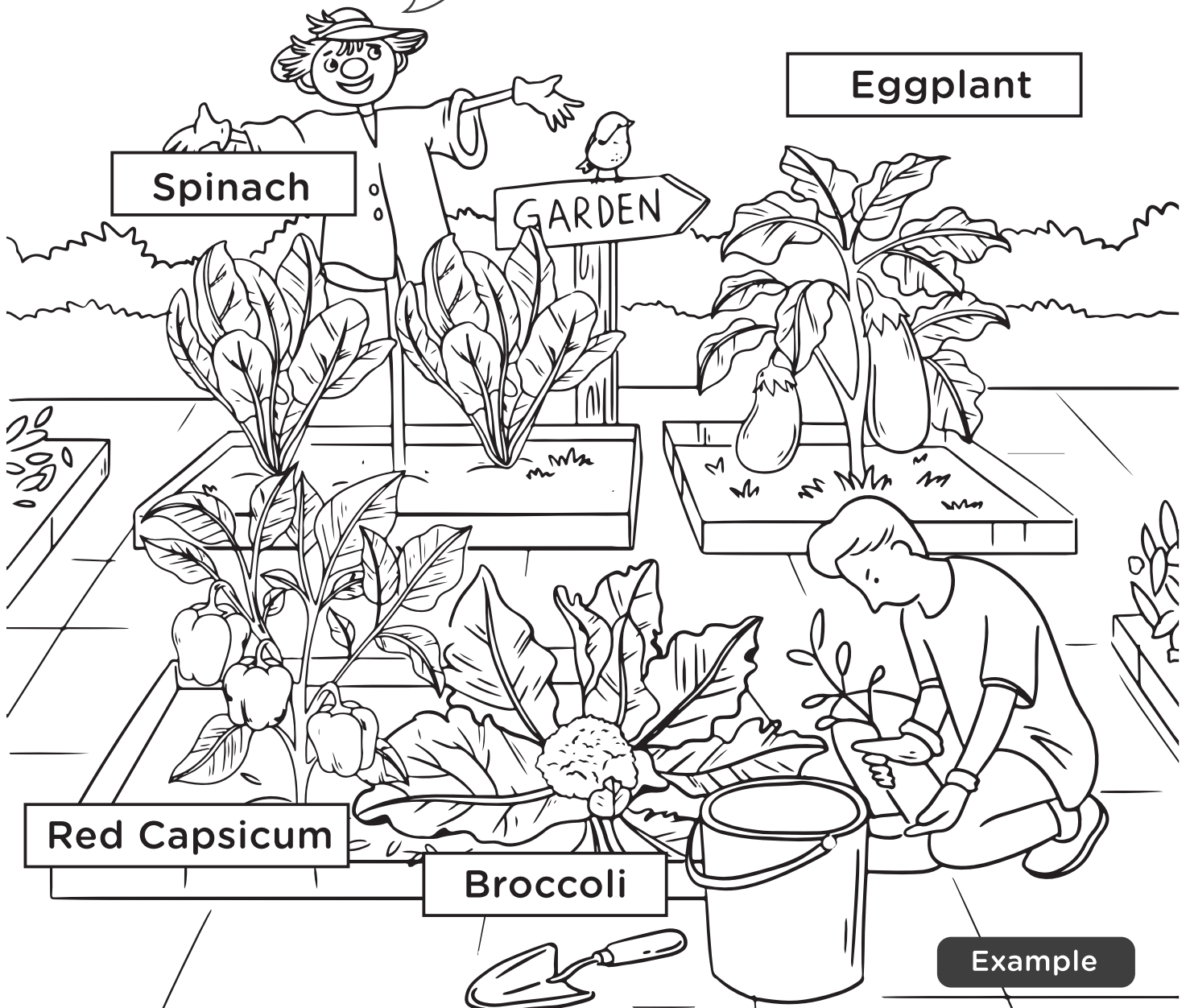

FRUITS

Lesson Objectives

For children to appreciate eating fruit.

Background Information

- We all know that we should be eating fruits, but the truth is most of us are not eating enough of them. Naturally refreshing and sweet, fruits make for healthy snacks that are high in vitamins and minerals - which are important nutrients for a child's growth. Fruits also contain dietary fibre, which provides bulk in the diet to help us feel full.

- **Fruits as part of a balanced diet**

We should aim to eat 2 servings of fruit and 2 servings of vegetables each day. There's a good variety for us to choose from. Examples of such fruits are apples, pears, watermelons, mangoes, guavas, papayas and bananas.

We should enjoy a wide variety of food, taken in moderation and in the right balance.

- **Eating a rainbow of fruits**

Different fruits form a colourful spectrum, like the rainbow. The different colours of fruits and vegetables indicate the different nutrients they contain.

To enjoy the benefits of all these nutrients, we should eat a variety of different fruits.

- **Red fruits and vegetables** contain lycopene, which is good for the heart
- **Orange and yellow fruits** are rich in Carotenoids, Potassium, and vitamin C to boost your immunity
- **Blue and purple fruits and vegetables** contain Anthocyanin, an antioxidant that helps to support healthy blood pressure
- **Green fruits** are rich in calcium to help strengthen your teeth and bones
- **White fruits and vegetables** are rich in fiber and prevent constipation.

In a recent study conducted by the Health Promotion Board, we found that these fruits are especially popular among children aged 7 to 16:

- | | |
|--------------|----------|
| • Apple | • Grapes |
| • Watermelon | • Orange |
| • Mango | • Banana |

ACTIVITIES

Activity 1

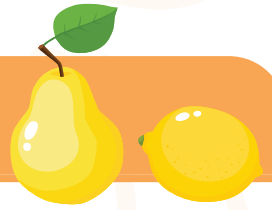

Put the puzzle pieces together to form a “Get Well Soon” fruit hamper.

Activity 2

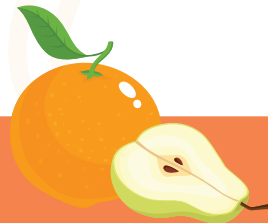

Work with NParks to obtain seeds to plant with the children in class. Watch and record the fruit or vegetable’s growth. Enjoy the pleasant surprise with the children in identifying the type of fruit or vegetable that matures in the plant.

Activity 3



Get children to observe, think about, and draw different types of fruits.

1. Your friend is sick and absent from school.
2. Discuss what your friend needs to get better soon.
3. Create a “Get Well Soon” card for your friend. In the card, tell your friend that fruits and vegetables can help to keep illnesses away.

Name: _____

Class: _____

Date: _____

Put the puzzle pieces together to form a "Get Well Soon" fruit hamper.

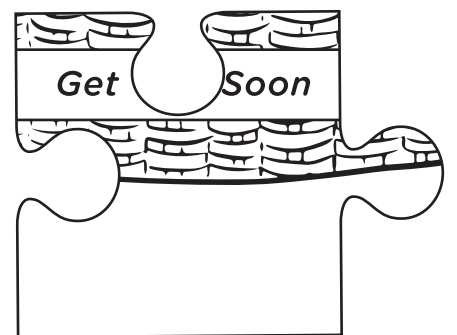
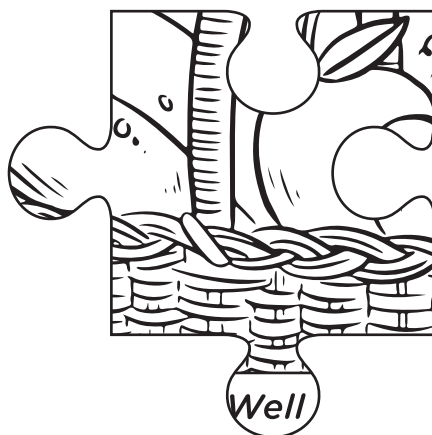
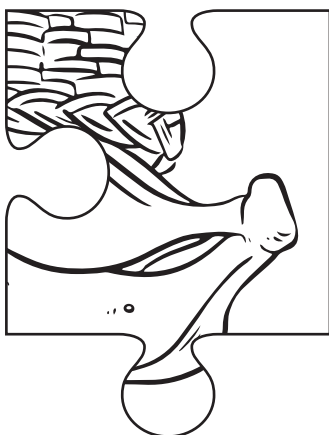
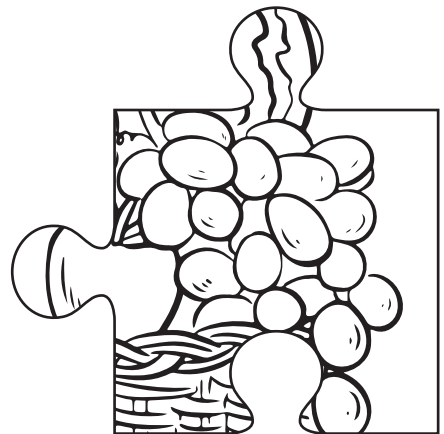
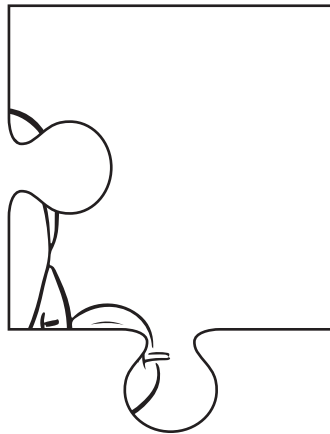
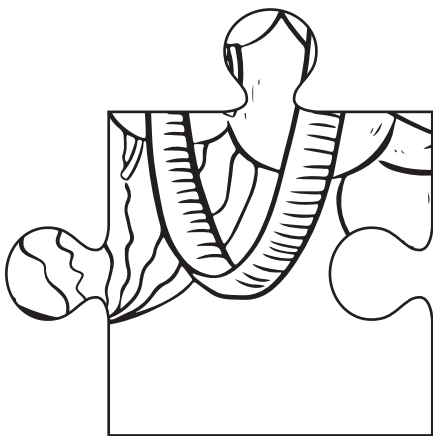
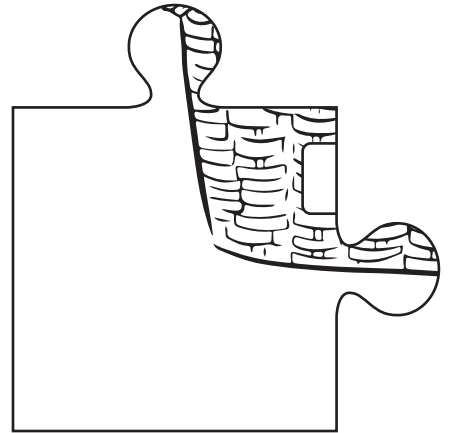
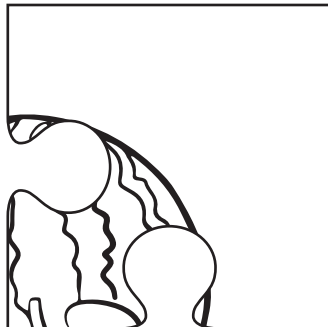
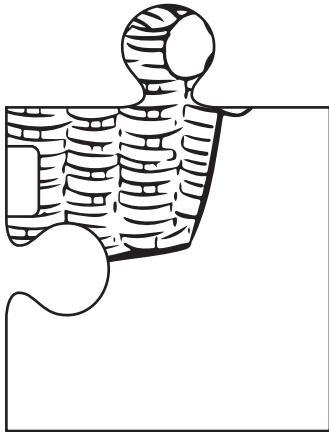

Name: _____

Class: _____

Date: _____

Work with NParks* to obtain seeds to plant with the children in class or school's garden. Watch and record the fruit or vegetable's growth. Enjoy the pleasant surprise with the children in identifying the type of fruit or vegetable that matures in the plant.

Date: _____

Date: _____

Date: _____

Date: _____

*Please refer to 'Every Child a Seed Programme' Link
<https://www.nparks.gov.sg/learning/programmes-for-schools/every-child-a-seed>

Name: _____

Class: _____

Date: _____

Get children to observe, think about, and draw different types of fruits.

- 1) Your friend is sick and absent from school.
- 2) Discuss what your friend needs to get better soon.
- 3) Create a "Get Well Soon" card for your friend. In the card, tell your friend that fruits and vegetables can help to keep illnesses away.



Get Well Soon Card

To:

From:

WHOLEGRAINS

Lesson Objectives

For children to understand the importance of wholegrains, and learn about the different types of wholegrain food sources.

Background Information

- A wholegrain is a grain that contains all 3 parts of the grain: the Bran, Endosperm and Germ:
 - **Bran** is the fibre-rich outer layer high in vitamin B, minerals and phytochemicals
 - **Endosperm** is the central starchy part, mainly made of carbohydrates and protein.
 - **Germ** is the nutrient-packed inner area that is high in vitamins B and E, trace minerals and phytochemicals.

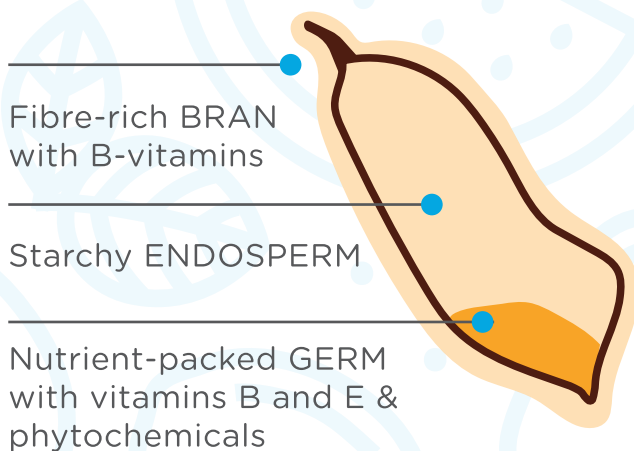

A refined grain, on the other hand, has the bran and germ removed during processing, leaving only the endosperm behind. As a result of this process, important nutrients and minerals are also lost - which explains why wholegrains are more nutritious than refined grains.

Wholegrains are also a good source of soluble and insoluble fibre:

- **Soluble fibre** helps to slow food digestion and helps you feel full, which discourages overeating.
- **Insoluble fibre** helps with ensuring smooth and regular bowel movements, helping to prevent constipation.

● There are many different types of wholegrain foods:

1. Wholegrain Rice

- Brown Rice - unpolished rice with a chewy texture
- Red rice - another variety of unpolished rice (like brown rice)

2. Wholegrain Bread

- Wholegrain and wholewheat breads are made of wholegrain and wholewheat flour and contain more fibre than white bread

3. Wholegrain Noodles

- Wholemeal beehoon (brown rice vermicelli), pasta and even soba are examples of wholegrain noodles

ACTIVITIES

Activity 1

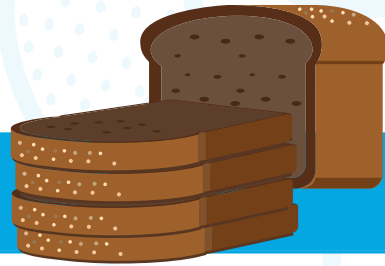

Cut out the food images and sort the food according to whether they are made of wholegrains or refined grains.

Activity 2

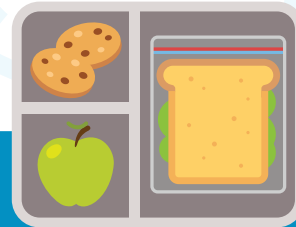

Make a paper lunchbox (refer to page 82 at the back of the booklet) filled with a balanced meal, including wholegrains! Share your lunchbox with the rest of the class, elaborating on the wholegrain you have chosen and why.

Activity 3



Get children to observe, think about, and draw different types of wholegrains through journal writing.









Name: _____

Class: _____

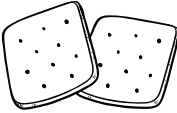
Date: _____

Cut out the food images and sort the food according to whether they are made of wholegrains or refined grains.

Wholegrains	Refined grains

				
Brown rice	Wholemeal crackers	Noodles	Plain crackers	White bread
				
Wholemeal bread	Wholemeal noodles	Chapati	Oats	White rice

Activity 2

Cut out the food cards along dotted lines and place into the lunch box.

Wholegrains

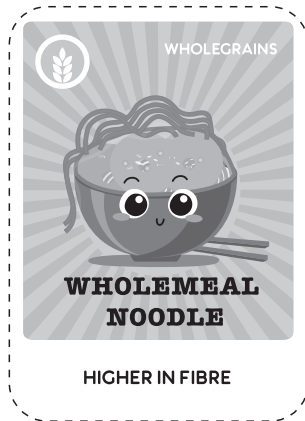
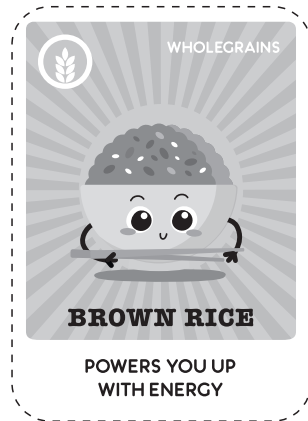

Meat & Others

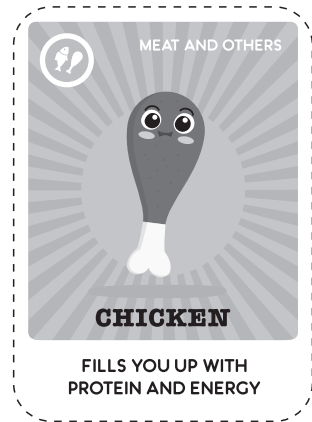
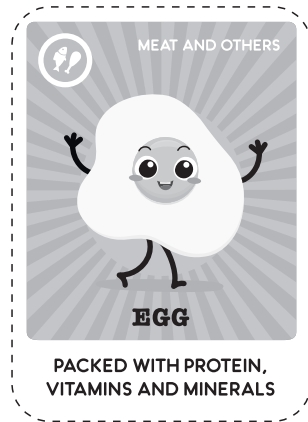

Fruit

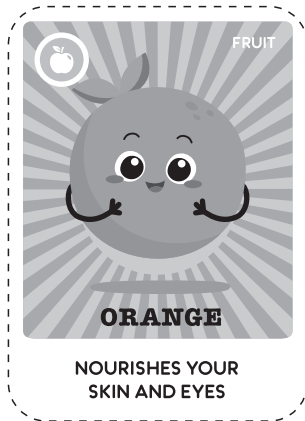
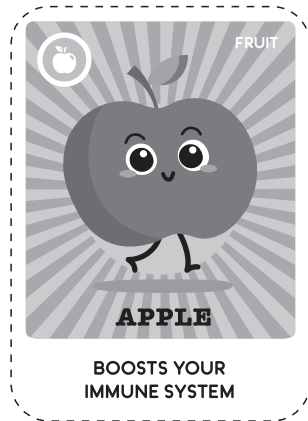

Vegetables

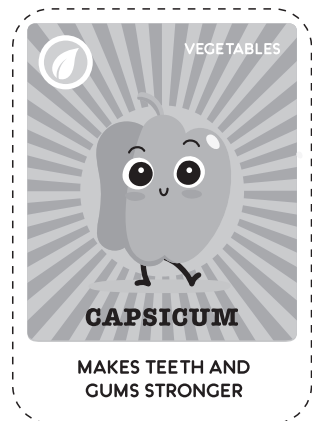
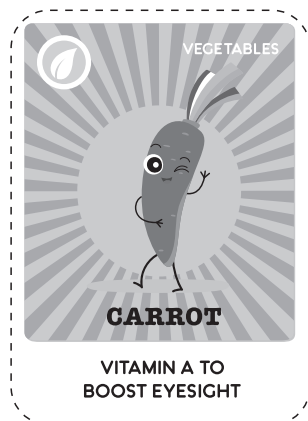

Name: _____

Class: _____

Date: _____

Fill up the bakery shelf by drawing wholemeal items.

Journal-Writing

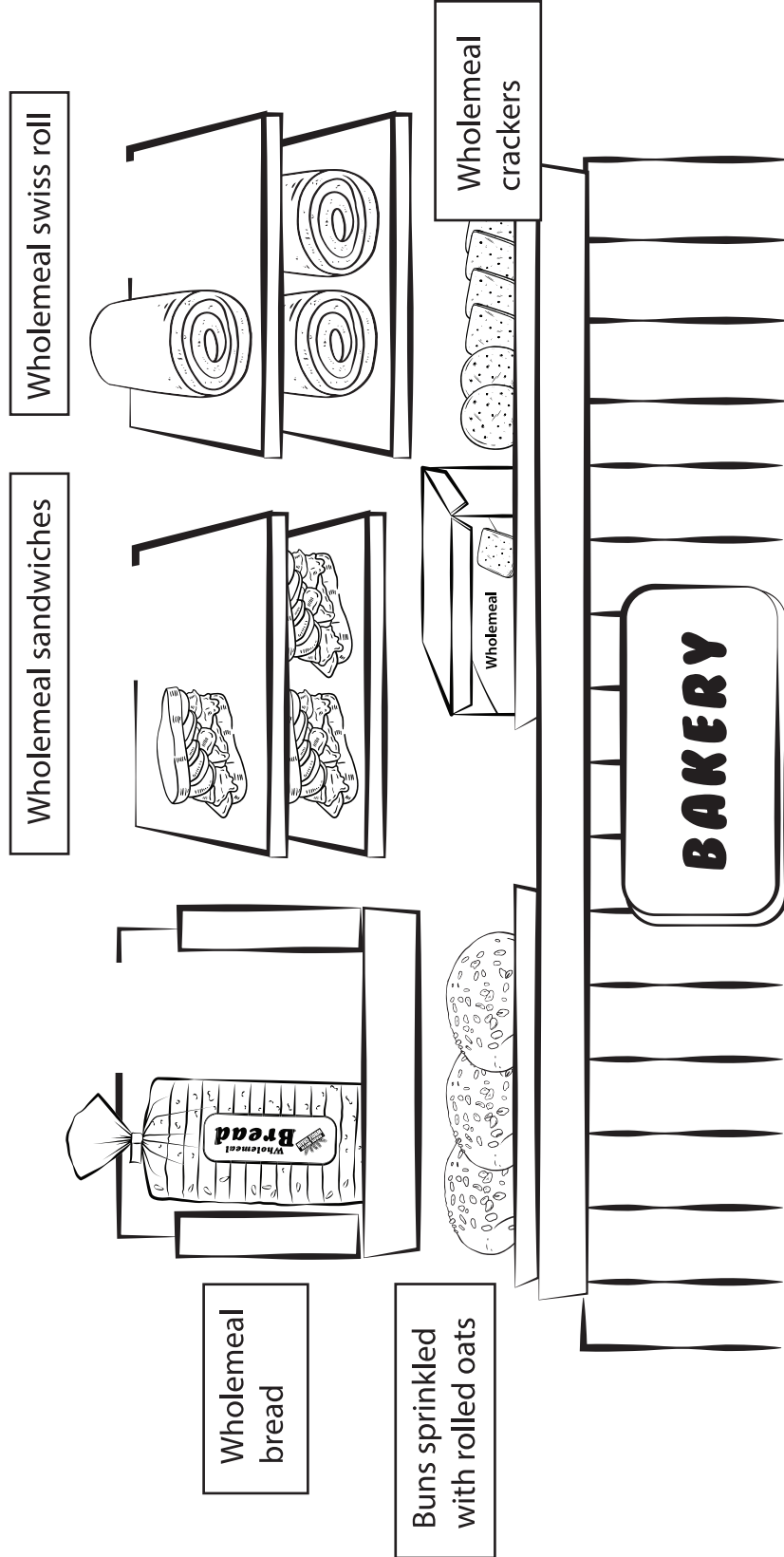

I went to visit the _____. I saw the _____.

I liked the _____ because _____.

CHAPTER 5

MILK

Lesson Objectives

For children to understand the importance of calcium, and learn about the different types of calcium food sources.

Background Information

- **Cows** provide estimated 90% of the world's milk supply. Cows are females (males are called bulls) and they can only give milk after they have given birth to a calf. What a cow eats affects the amount and quality of milk it can produce. A cow that eats only grass can produce 50 glasses of milk a day, while a cow that consumes grass, corn, hay and mixed feed can produce almost 100 glasses of milk. Modern milking machines can milk up to 100 cows per hour, compared to only 6 cows by hand.
- **Milk** is a source of many important nutrients that growing children need, including calcium, protein, vitamin A and some B vitamins.
- **Calcium** is the key building block for strong, healthy bones and teeth. Our bones continue to grow through our childhood and teenage years, making this the best time for us to strengthen our bones.

We should aim to eat more foods high in calcium such as milk, yoghurt and cheese during this time, so that we can build stronger bones while we can!

ACTIVITIES

Activity 1

1.1. Sing along to 'Mrs Cow'



1.2. Children to be divided into 2 groups.

- Gather children to watch the video.
- Video - Where does milk come from?



- Teacher may replay again as it is a short video.
- Using the picture cards, get children to talk about how milk is produced.



Activity 2

Calcium Cheer

Give me a **C**
Give me a **A**
Give me a **L**
Give me a **C**
Give me a **I**
Give me a **U**
Give me a **M**

What do you get?
CALCIUM! Yeah!



ACTIVITIES

Activity 3



Activity 3.1

1. Gather children around the table.
2. Teacher to divide the class into 2 groups.

Group A

Children to place the picture cards at the learning corner to create opportunities to play and interact with their peers as they learn how milk is produced through the cards.

Group B

Teacher to engage with children by sharing the different types of milk available, such as flavoured milk, low-fat milk and full cream milk. Teacher may present these milk varieties for children to taste and get them to share their thoughts and preferences.

Activity 3.2

- Allow children to draw their favourite calcium-rich foods.
- After drawing, encourage children to share their drawings and start with the sentence: “This is my favourite food because it gives my body calcium to help grow and strengthen my bones”.

Activity 3.3

- Children to draw the ingredients for Banana Berry Delight to complete the recipe book.

Name: _____

Class: _____

Date: _____

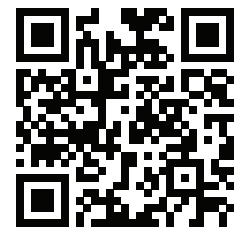
Song: Mrs CowLyrics

**Dear Mrs Cow
Dear Mrs Cow
I like to thank you for all you produce
Today my teacher has taught us
About your body working hard all day long**

**You give us milk and milk caramel
And the butter that I always eat with the bread
You give us cheese to make us strong
And the yoghurt for my brother
Dear Mrs Cow
You do know how to work**



Name: _____

Class: _____

Date: _____

Talk about how milk is produced:



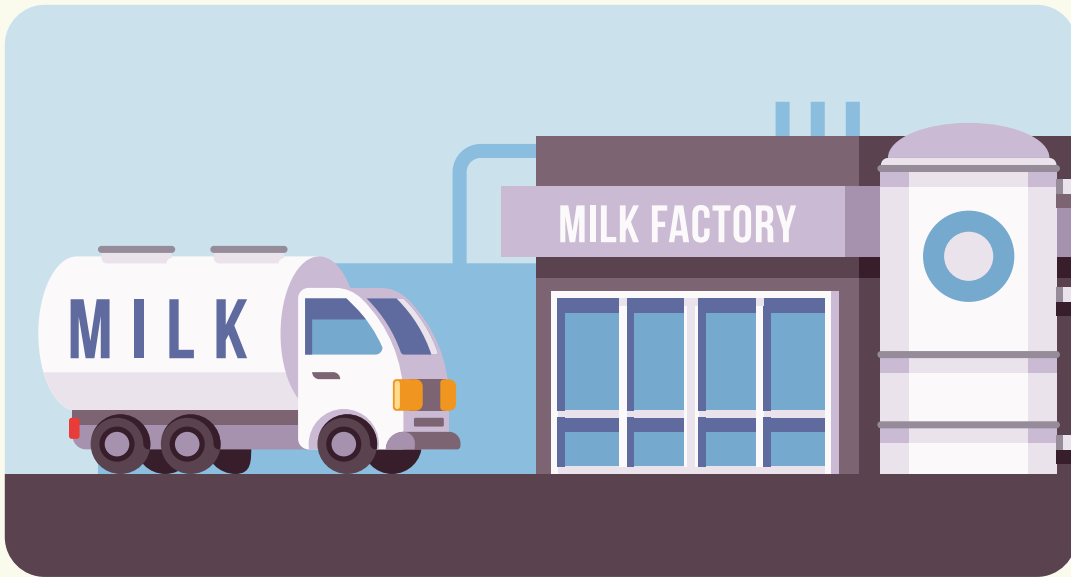

Name: _____

Class: _____

Date: _____

Calcium Cheer

Give me a **C**

Give me a **A**

Give me a **L**

Give me a **C**

Give me a **I**

Give me a **U**

Give me a **M**

What do you get?

CALCIUM! Yeah!

Name: _____

Class: _____

Date: _____

- 1 Gather children around the table.
- 2 Teacher to divide the class into 2 groups.

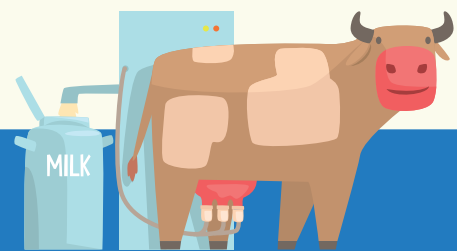

Group A



Children to place the picture cards at the learning corner to create opportunities to play and interact with their peers as they learn how milk is produced through the cards.



Group B



Teacher to engage with children by sharing the different types of milk available, such as flavoured milk*, low-fat milk and full cream milk. Teacher may present these milk varieties for children to taste and get them to share their thoughts and preferences.

** To choose those with Healthier Choice Symbol as they have 25% less fat and sugar*

Name: _____

Class: _____

Date: _____

Draw your favourite calcium-rich foods.



This is my favourite food because it gives my body calcium to help grow and strengthen my bones.....

Name: _____

Class: _____

Date: _____

Recipe for Banana Berry Delight

Complete the recipe book by
drawing the ingredients for
Banana Berry Delight.



1 Banana	3/4 Cup of Strawberries	1 1/4 Cup of Milk
2 Tablespoons of Plain Yoghurt	1 Tablespoon of Honey	

Y _ _ _ _ t and m _ _ k give us cal _ _ um.

BEANS

Lesson Objectives

For children to understand the importance of beans as a source of protein, and learn about the different types of beans and how they can be eaten.

Background Information

Beans are dried seeds of plants belonging to the legume family. They grow and ripen in pods and are harvested when dry.

In Singapore, beans are imported from many parts of the world: we have lentils from India, red (adzuki) beans from China and soya beans from the United States.

There are many different ways of enjoying beans:

- **Cooked beans** such as baked beans are made by soaking dried beans, boiling them, then cooking them in a sauce. Cooked beans are soft and easier to digest.
- **Bean paste** such as red bean paste in buns and biscuits are made by cooking red (adzuki) beans, mashing them and sweetened.
- **Roasted beans** such as snacks like roasted grams, soy beans or broad beans, are made by roasting beans and usually adding a seasoning such as salt or garlic powder.
- **Soy bean products** such as tau huay (soft beancurd dessert), beancurd (tofu) or soya bean milk are made from boiling soya beans and crushing them.
- **Beans as main ingredients** such as idli (steamed lentil and rice patties) and vadai (lentil fritters) are used in Indian dishes.

Beans as a source of protein

Protein is needed by our bodies to grow and repair tissues. As children are still growing, they need to have enough protein to support this growth.

Protein generally comes from two sources: animals and plants. Beans are a type of plant protein.

In general, plant sources of protein are considered to be incomplete as they lack one essential amino acid. However, protein from soya beans contain all the essential amino acids needed to make body proteins. This is why soya beans and soya products are called the complete plant protein.

Soya and other bean products are good for overall health and should be part of a healthy balanced diet.

ACTIVITIES

Activity Prelude

Teacher tells the story of Jack and the Beanstalk with the aid of a storybook and a video such as:



and



Activity 1

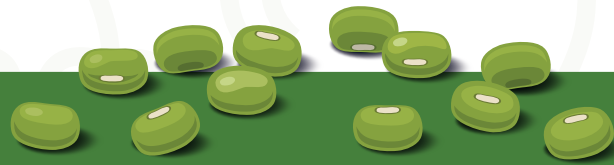

Activity 1.1

- After the storytelling session, teachers to discuss the story with the children, emphasising on the word 'beans'.
- Teacher takes this opportunity to introduce the children to different types of beans such as soya beans, green beans and red beans.
- Teacher may use flash cards or bring real beans to the classroom.

Activity 1.2

- After the storytelling session, children can explore the learning corners to either:
 - i. Colour a template with pictures of soya beans, green beans & red beans.
 - ii. Sort the 3 types of beans.

Teachers to prepare a container of mixed beans. Children to then sort the beans accordingly.

Activity 2

After the storytelling session, teachers to discuss the story with children, emphasising on the word 'beans'.

Teacher takes this opportunity to introduce children to different types of beans such as soya beans, green beans and red beans.

After the storytelling session, teacher and children plant green beans together.

Resources needed:

- Recycled bottles/ plastic cups or containers
- Wool
- Green beans

Steps

1. Place the wool in the bottle.
2. Wet the wool.
3. Place green beans on the wet wool.

*Teacher should help the children to place the containers at an appropriate place in class, where they are exposed to sunlight and can also be easily observed daily.

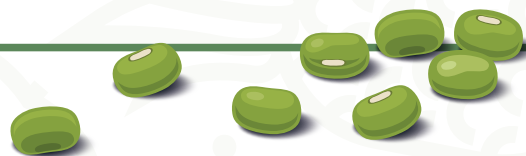

Activity 3

Activity 3.1

- Children can take turns to roleplay a seed that grows into a giant beanstalk.
- After the roleplay session, teacher to introduce different types of beans using flash cards – such as soya beans, peas, chickpeas and kidney beans. During this discussion, teachers should also explain the importance and benefits of eating beans.

Activity 3.2

- After the discussion, children are given the opportunity to journal (i.e. draw and write) their learnings and reflections in the ‘My Beans Book’ (foldable).

Example:

Child will draw a pea pod in the box and colour it.

**“This is a pea pod.
Peas are green.”**

**“This is soya bean.
I love soya bean drink”.**

Closure:

Children may be served a soya bean drink, green bean soup or red bean soup during tea-time.



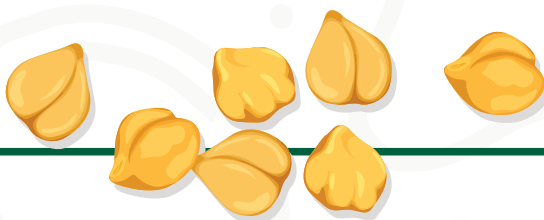

Name: _____

Class: _____

Date: _____

Identify the different types of beans.



Soy beans

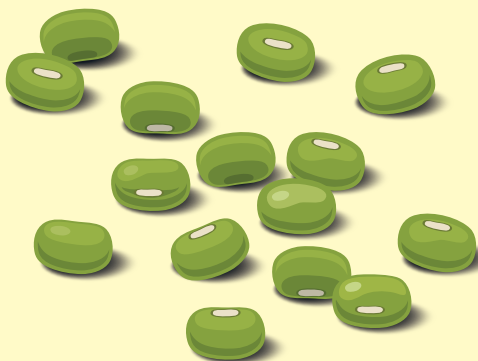

Green beans

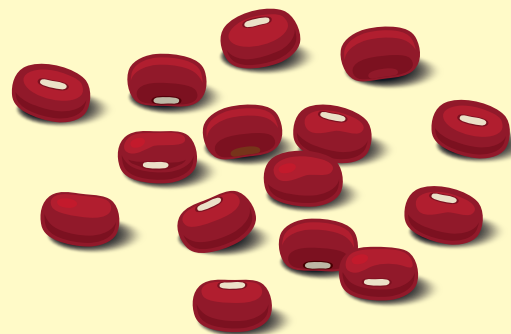

Red beans

Name: _____

Class: _____

Date: _____

Colour the pictures of soya beans, green beans and red beans.

Soy beans

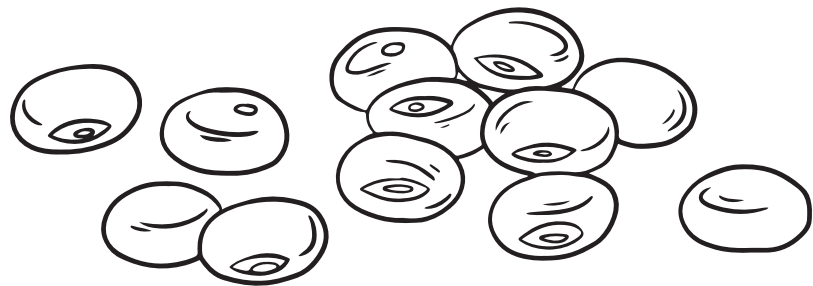

Green beans

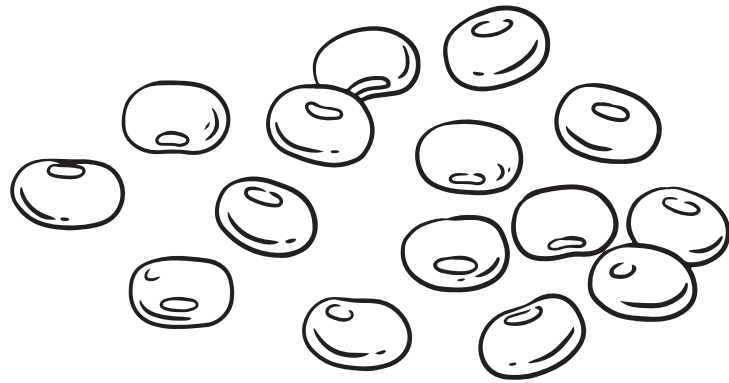

Red beans

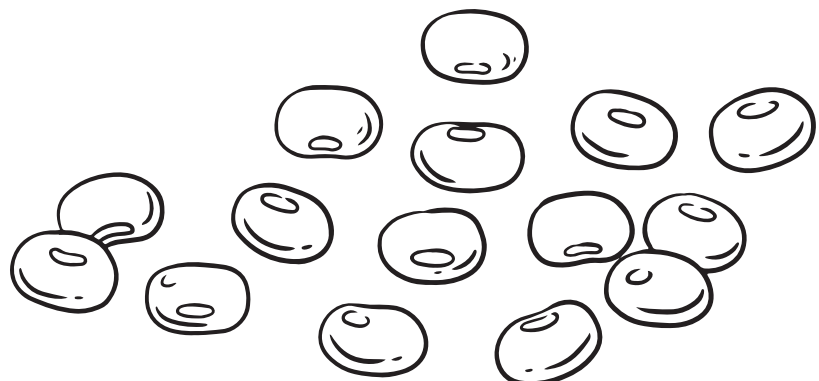

Name: _____

Class: _____

Date: _____

Planting green beans together

Resources needed:

- Recycled bottles/ plastic cups or containers
- Wool
- Green beans

Steps:

1



Place the wool
in the bottle.

2



Wet the wool.

3



Place green beans
on the wet wool.

*Teacher should help the children to place the containers at an appropriate place in class, where they are exposed to sunlight and can also be easily observed daily.

Name: _____

Class: _____

Date: _____

Teacher to introduce different types of beans and importance of eating beans for the body.

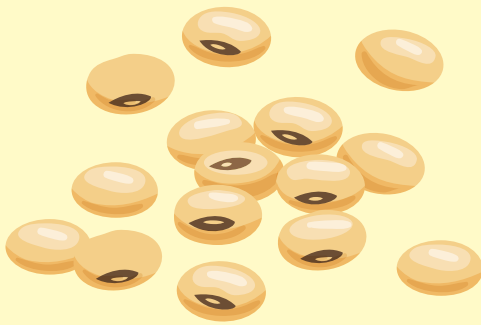

Soy beans



Peas



Chickpeas

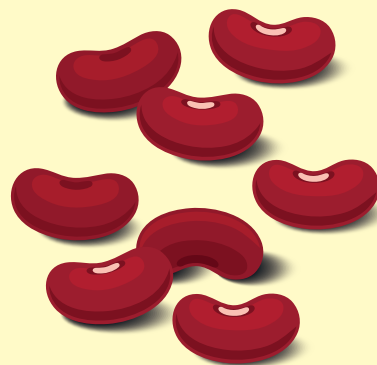



Kidney beans

Name: _____

Class: _____

Date: _____

Children to draw and write learnings on "My Beans Book"

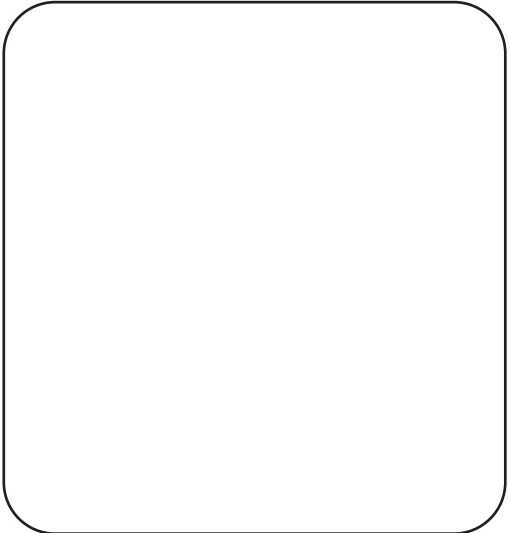
<hr/> <hr/> <hr/> 	<hr/> <hr/> <hr/> 
 <hr/> <hr/> <hr/>	<p>My Beans Book</p> 

CHAPTER 7

FISH & MEAT

Lesson Objectives

For children to understand the importance of fish as a source of good fats (Omega-3), identify the different parts of a fish, and name at least 2 farm animals that provide meat.

Background Information

Fishes

We differentiate fish by their shape, size, colour and taste. There are many types of fishes:

- **Flat fishes** like pomfret, big fishes like sea bass.
- **Tiny little fishes** like anchovies (Ikan bilis) and herrings, which are silvery-coloured.

We can tell the colour by the fish's name too: for example, white or black pomfret and red snapper.

What do fishes eat?

Big fishes eat smaller fishes, and small fishes eat plankton (very tiny animals and plants that float in the sea).

How do we catch fish?

We catch fish using a fishing net, hook and line or basket.

Where do fishes grow?

It depends on the type of fish:

- Freshwater fishes grow in ponds and rivers
- Saltwater fishes grow in the sea

What are some examples of popular local fishes?

- Sardine, Tuna, Sea Bass, Pomfret, Yellow tail, Ikan Kuning, Tilapia, Red Grouper, Selar.

Why should we eat fish?

- Fish is a source of protein Omega-3, which is a 'good fat' that lowers the risk of heart disease. It also helps to reduce blood clotting in the arteries and lowers the level of triglycerides (a type of fat) in the blood.

Shellfish

- Lobsters, crayfish, crabs and prawns have shells, and so are called shellfish.

What do shellfish eat?

- Lobsters eat other sea animals.
- Crabs live at the bottom of the sea and they use their claws to catch fish and other shellfish. They also like to eat seaweed.
- Other shellfish like clams and scallops live inside their shell. They eat plankton.
- Squid (Sotong) and octopus eat fish, prawns and other sea animals.

Meat

The meat we eat comes from animals that live on farms, such as cattle (beef), pigs (pork), sheep (mutton) and goats (lamb), and chicken, ducks and turkey (poultry).

Cattle eat grass, hay and mixed feed consisting of ingredients like corn, oats, barley and soya beans. Cattle usually graze in open fields and live in pens. A family is made up of a bull (male), a cow (female) and calves (young).

Pigs live in sties and eat cereals like wheat, barley, corn and sometimes potatoes, milk and fishmeal. A family is made up of a boar (male), a sow (female) and piglets (young).

Sheep eat grass and weeds and they live in pens. A family is made up of a ram (male), ewe (female) and lambs (young).

Goats eat grass, hay and cereals like oats and corn. They also like to nibble at apples, tree bark and tender new branches of a tree. They live in pens. A family is made up of a billy goat (male), a nanny goat (female) and kids (young).

Chickens eat a variety of food; from seeds, grass, insects, and worms to green leaves. They also like to eat mash, which is a mixture of cereals, fish and soya beans. They live in coops or henhouses. A family is made up of a rooster (male), a hen (female) and chicks (young).

Ducks eat grass, cereals, and also worms and assorted grub (larva of an insect). If they swim, they can catch tadpoles and fishes to eat. Ducks are good helpers in padi fields as they pull weeds. They live in huts. A family is made up of a drake (male), a duck (female) and ducklings (young).

The types of meat we eat may be influenced by our religions, morals and family preference:

- **Muslims** eat halal (ritually slaughtered) meat and avoid pork and pork products.
- **Hindus and some Sikhs** avoid beef and may avoid meat entirely on “fasting” days.
- **Buddhists** may also avoid beef.
- **Jews** eat kosher (ritually slaughtered) meat and avoid eating meat and dairy products together at the same setting.
- **Catholics** may avoid eating meat on Fridays and during Lent.

ACTIVITIES

Activity 1

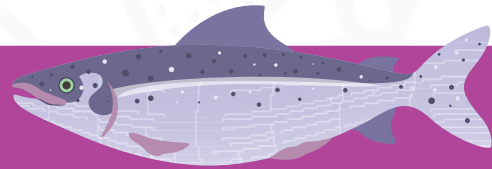

To teach children how to identify different types of fishes - Shark, Mackerel and Salmon. With the aid of flashcards, teacher introduces 'Shark', 'Mackerel' and 'Salmon'.

After the introduction, teacher sings along with the children to the **Baby Shark song**

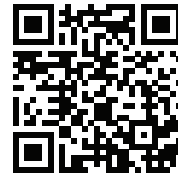

- For the next activity, teacher gets a child to choose a flashcard.
- If the child picks a flash card showing Mackerel, they will sing "Mackerel, doo, doo".
- Repeat the song with the other fish names.

Extended Activity:

Teacher can prepare "Fishing Activity" at the learning corner.

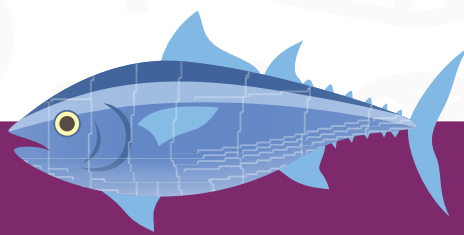

Activity 2

To introduce the children to the different parts of a fish.

*Only focus on fish eyes, mouth, gills, fin, tail and body.

- Teacher and children to sing along to the Baby Shark song.
- With the aid of the 'parts of fish' template, teacher introduces the parts of the fish and their main functions.
- Teacher then gets children to create a fish collage using resources in the class such as recycled bottle caps.
- Children proceed to label the different parts of fish on their art work, with the help of the teacher.



Activity 3

Children should be able to name two farm animals that provide meat.

- Teacher and children to sing along to 'Old Macdonald had a farm'.
- Children can change the name of the animals in the song.
- Teacher can proceed to the 'Talk about the picture' activity.

Identify the different types of fishes.

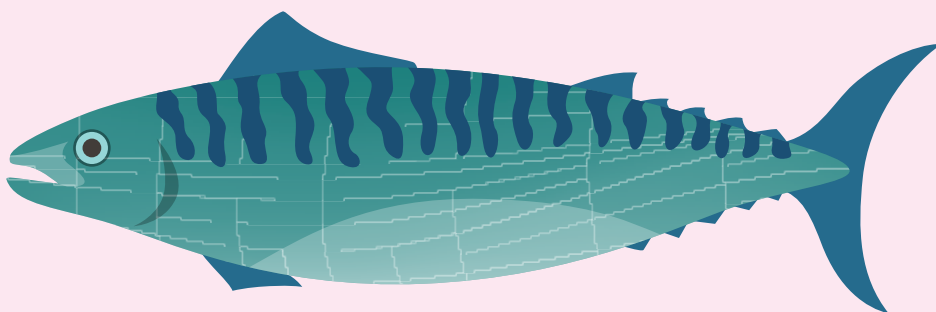
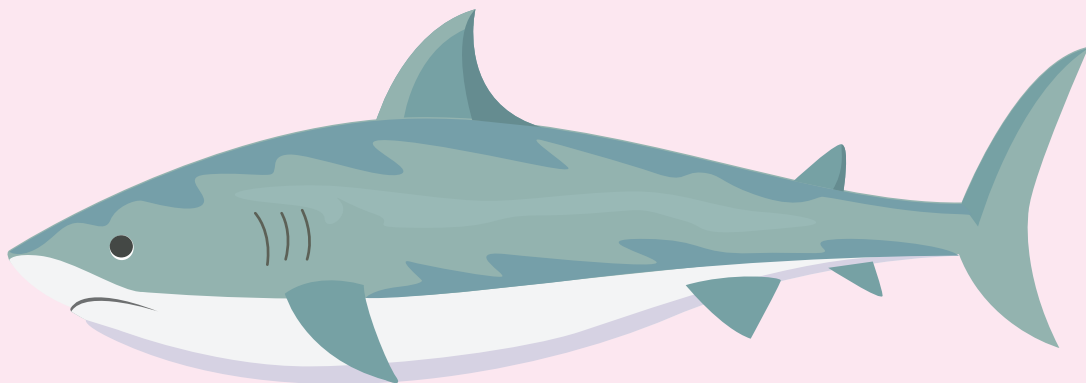
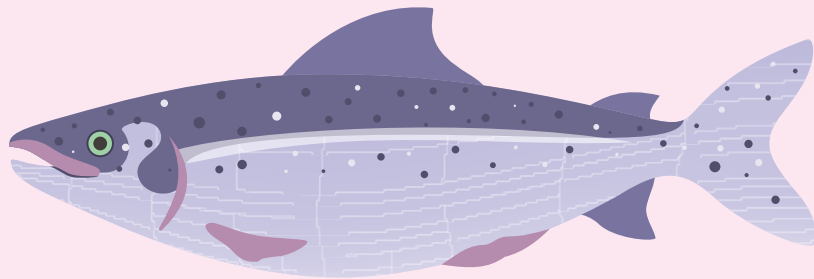

Name: _____

Class: _____

Date: _____

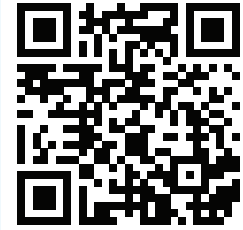
Song: Baby SharkLyrics

Baby shark, doo doo doo doo doo doo doo
Baby shark, doo doo doo doo doo doo doo
Baby shark, doo doo doo doo doo doo doo
Baby shark!

Mommy shark, doo doo doo doo doo doo doo
Mommy shark, doo doo doo doo doo doo doo
Mommy shark, doo doo doo doo doo doo doo
Mommy shark!

Daddy shark, doo doo doo doo doo doo doo
Daddy shark, doo doo doo doo doo doo doo
Daddy shark, doo doo doo doo doo doo doo
Daddy shark!

Let's go hunt, doo doo doo doo doo doo doo
Let's go hunt, doo doo doo doo doo doo doo
Let's go hunt, doo doo doo doo doo doo doo
Let's go hunt!
Run away...

Activity 1

(Extended Activity)

Name: _____

Class: _____

Date: _____



Fishing Activity

Prepare the following:

1. Using sample fishes below, cut along dotted lines and make a few more fishes.
2. Assemble a fishing hook made of stick, string and blue tac/sticky tape.
3. Child to sit on a chair and try to hook as many types of fishes.



Name: _____

Class: _____

Date: _____

Parts of the fish

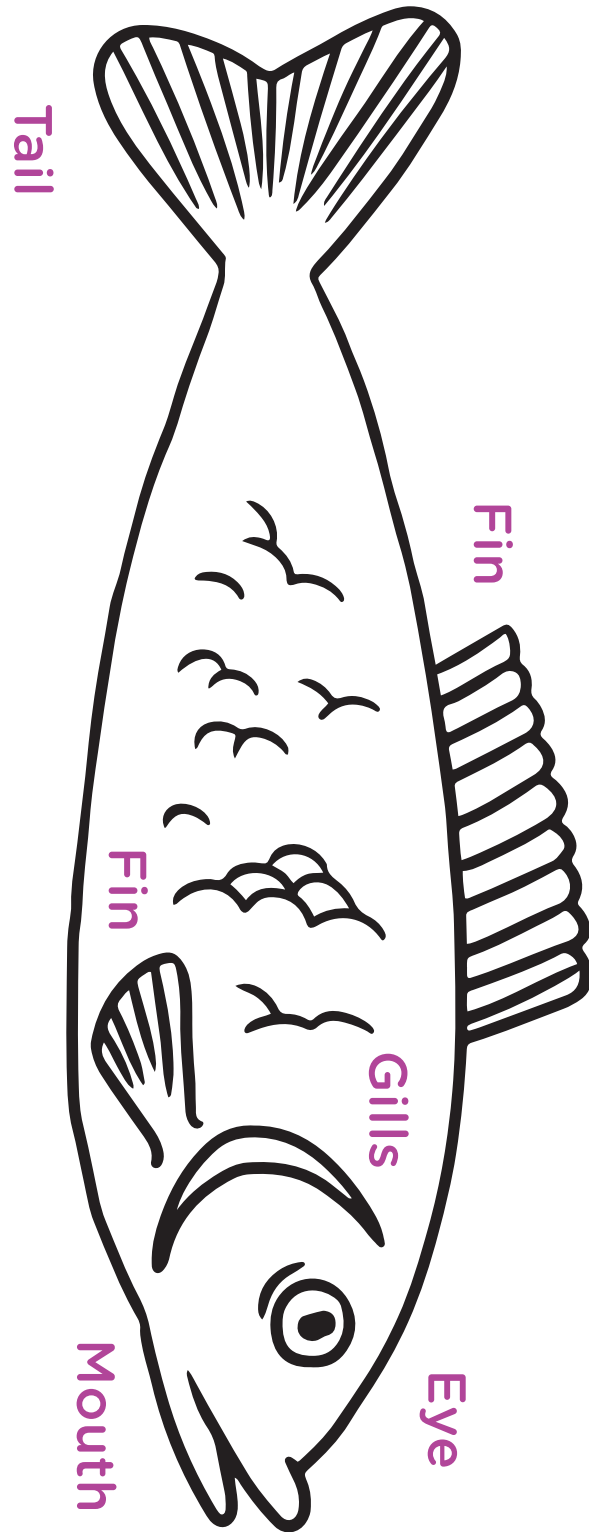

Name: _____

Class: _____

Date: _____

Talk about the picture

Teacher to ask these questions:

- Can you name some animals that live on a farm?
- What types of meat do these animals give us?
- What other food do chickens, ducks and cows give us?



HEALTHIER CHOICES

Lesson Objectives

For children to identify foods that are healthier and more nutritious using the Healthier Choice Symbol (HCS). They should also be able to identify fruits, vegetables and wholegrains as healthier snack options.

Background Information

The Healthier Choice Symbol (HCS) can be found on a wide range of packaged food products, from bottled and instant beverages to oils, grains and snacks. The symbol makes it easy to identify the healthier option when comparing two similar products.

There are currently six different taglines explaining what makes a product the healthier choice:

1. Higher in wholegrains
2. Higher in calcium
3. Lower in sugar
4. Lower in saturated fats
5. Lower in sodium
6. Trans fat free

Some products may carry more than one tagline – for instance, an oat beverage may be both higher in wholegrains and lower in sugar.

Variety, balance and moderation is key to a healthy, balanced diet. You can include a variety of HCS products as part of your diet. However, like all foods, even HCS foods should be eaten in moderation.

Why do we snack?

Snacks help to keep us full in between meals. Young children with active lifestyles may encounter difficulties consuming enough food at mealtimes to last them till their next meal.

What makes a good snack for children?

‘Good’ snacks are healthy, easy to prepare and consume, and taste good. Such snacks should help children refuel their energy and contribute towards their daily protein, vitamins and minerals requirements.

Here are some snack choices from the food groups we have discussed from lesson 1 to 4:

- **For energy:** Wholegrain snacks such as wholegrain bread/sandwiches, wholemeal biscuits and wholegrain breakfast cereals.
- **For strength:** Protein-rich snacks such as eggs, beancurd, baked beans, tuna, sardines, chicken, meat and soya bean milk.
- **For strong bones:** Calcium-rich snacks such as milk, yoghurt and cheese.
- **For keeping us healthy and preventing us from falling ill:** Vitamin-rich snacks such as fruits and vegetables.

ACTIVITIES

Activity 1

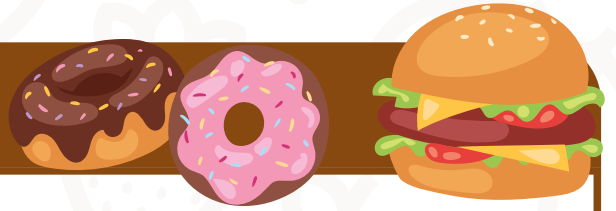

Song: Johnny, Johnny, Yes Papa:

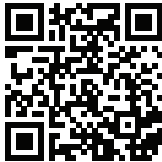

- Before singing this song, teacher gets the children to name some of their favourite snacks.
E.g.: Chocolates, brownies, apple slices, etc.
- Repeat the song.
- After singing, teacher can use the Healthier Choice placard to teach children how to choose healthier snacks.
- Sing the song again. This time, children only can name healthy foods while singing.

Activity 2

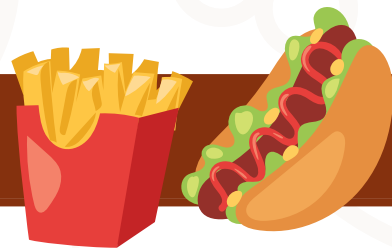

Visit to the Supermarket

- Teacher talks about the HCS and its significance when choosing snacks.
- Teacher then informs children that they are going to the neighbourhood shop or supermarket, where they will look for food items in the dairy section bearing the HCS.
- Upon returning to the school/centre, children will share their findings and discuss their experiences.

Activity 3



Visit to the Supermarket

- Teacher talks about the HCS and its significance when choosing snacks.
- Teacher then informs children that they are going to the neighbourhood shop or supermarket, where they need to look for 4 food items bearing the HCS.
- Upon returning to the school/centre, children will fill up the activity sheet.

Encourage parents to bring empty food packages bearing the HCS. Using these, teachers may set up a corner for 'Our Healthy Food Store'.

Name: _____

Class: _____

Date: _____

Song:

Johnny, Johnny, Yes Papa



Lyrics

Teacher: Johnny, Johnny

Children: Yes, Papa

Teacher: Eating sugar

Children: No, Papa

Teacher: Open mouth

Children: Ha, ha
(and open their mouth)

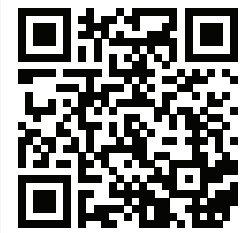

Name: _____

Class: _____

Date: _____

Visit to the Supermarket

- Teacher talks about the HCS and its significance when choosing snacks.
- Teacher then informs children that they are going to the neighbourhood shop or supermarket, where they need to look for food items in the dairy section bearing the HCS.
- Upon returning to the school/centre, children will share their findings and discuss their experiences.



Name: _____

Class: _____

Date: _____

Visit to the Supermarket

I found four food items that have Healthier Choice Symbol.



Higher in Calcium



Lower in Sugar



Higher in Wholegrains



Lower in Saturated Fat

I chose these because.....

CHAPTER 9

WATER

Lesson Objectives

For children to learn that plain water is the best choice of drink.

Background Information

● What makes water great?

Our bodies are 70% water. To illustrate, imagine if we were to have nutrition labels like food do. Our main ingredient would be water.

Water has many functions in our body. One of its main functions is to carry food in and waste products out of our cells. Water also helps to control our body temperature and keeps us from overheating.

However, water is constantly being lost from our body, such as when we go to the toilet and when we perspire. If we do not drink enough water, we also tend to get dehydrated and feel unwell.

● Are you getting enough water?

In Singapore's hot climate, we are constantly losing water through perspiring and other body functions that keep us from overheating. That's why it is very important to drink enough fluid to replace the water that's being lost.

For children, this means drinking regularly, especially before or after exercising or when outdoors in the sun.

The best thing to drink when we are thirsty is water. It's refreshing, has zero calories and keeps our bodies functioning well. Some foods that are also good sources of water include milk, juice and soup. They supply nutrients as well as fluid.

- **Different types of drinks**

- (i) Fruit juices**

Fresh fruit juices do contain some nutrients, but eating a fresh fruit is a better option. This is because eating the fruit also provides dietary fibre and nutrients that are not found in the juice.

Fruit juices also contain more sugar than the whole fruit, as it takes three to four oranges to fill a glass with orange juice. In comparison, we are unlikely to eat four oranges at a go.

- (ii) Sugary, flavoured drinks**

Popular drinks such as cordial, sweetened fruit drinks and fizzy drinks may taste good, but are often unhealthy as they are high in sugar, which can lead to weight gain, obesity and tooth decay.

Frequent consumption of such sugary drinks can decrease children's appetite for more nourishing food and drinks. Instead, they may even become addicted to the taste of sweet drinks and the feeling of 'sugar rush' that comes along with it.

- **Choosing water over sugary drinks**

The best approach is for parents to cultivate a lower preference for sugar in children by reducing their frequency and exposure to sweetened beverages from a young age.

Parents should also encourage drinking lots of water, alongside the consumption of fresh fruits, vegetables and wholegrains to help keep them full and satiated without a sugar rush.

- **Spice up your drink**

- Freeze small pieces of fruits such as grapes, sliced oranges and strawberries, and use them as ice cubes to chill your drink and add subtle flavour at the same time.
- You can also add a handful of fresh herbs, such as mint or basil, into a pitcher of water and let the herbs infuse overnight. Add a few refreshing slices of cucumber or oranges for more flavour.

ACTIVITIES

Activity Prelude (Each activity will start with this)



Jingle (Ban Ban Drinks Water)

- Teacher to sing along the jingle with the children.

Activity 1

- After singing along to the jingle, children may proceed to complete the worksheet at the learning corner.

Activity 2

- Teachers and children make lime juice after introduction of the jingle.
- After the activity, children can proceed to complete the 'Sip, Sip, Sip' worksheet at the learning corner.



Activity 3



How much sugar is in your drinks?

- Teacher performs a simple experiment to find out the sugar content in popular drinks.
- Teacher to prepare the following items:

Items:

- a) Food weighing scale
- b) 2 cans of carbonated drinks
- c) 1 packet of fruit juice
- d) 1 packet of plain milk and flavoured milk
- e) Sugar
- f) Small plastic bag
- g) Markers

Teacher to do the following:

- Gets children to read the sugar content on the packages and asks them to guess how much sugar is in each drink.
- Takes one drink at a time and weigh sugar according to the amount indicated in the label.
- Places the sugar in a small plastic bag, ties and labels it accordingly.
- Informs children to record their findings on the activity worksheet when experiment is completed.



Jingle:

Ban Ban Drinks Water

Lyrics

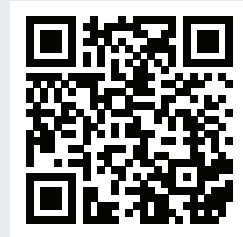

When you're thirsty, drink water.

Slurp, slurp, ha.

When you feel hot, drink water.

Slurp, slurp, ha.

When you feel sick, drink water.

Slurp, slurp, ha.

Drink water at school.

Drink water at home.

Drink water at play.

You slurp, I slurp, everyone slurp.

We're all healthy kids.



Name: _____

Class: _____

Date: _____

Help me find my water.

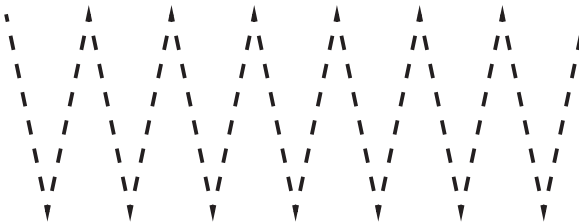

Making Lime Juice

Ingredients (makes 2 litres)

200ml lime juice (from 35 fresh limes)

700ml sugar syrup (100g sugar + 700ml water)

1000ml cold water

Ice cubes (optional)

Utensils / equipment

Measuring jug

Sieve

2-litre jug

Long spoon

Glasses (1 per child)



How to :

1. Have an adult cut the limes into half. Children can then squeeze the juice from the limes into the measuring jug, over a sieve.
2. Collect the lime juice and pour into the 2-litre jug. Add 1-litre of cold water. Pour a little into a glass for a child to taste. Discuss the taste: is it sweet or sour?
3. Add in half of the sugar syrup. Have another child taste the mixture. How does it taste? Does it need more sugar syrup? Add more if necessary. Ask another child if it is sweet enough. Add the remaining syrup if necessary.
4. Keep the lime juice in the refrigerator until snack time. Serve with ice cubes if desired. Remind the children to rinse their mouths with water after taking a sweet drink.



Name: _____

Class: _____

Date: _____

Sip, Sip, Sip

Drink plenty of water during playtime.

Some drinks here contain a lot of sugar and are not healthy for you.

Cross out (X) the drinks that you should only take once in a while.

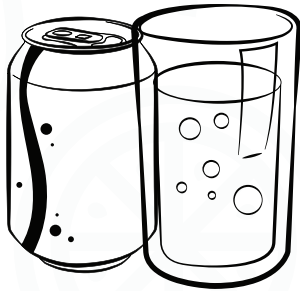
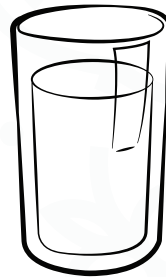
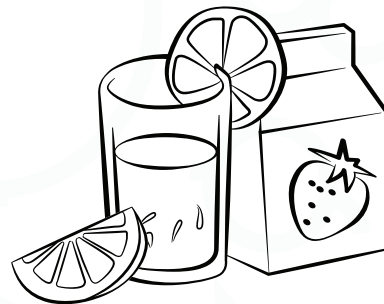
**Carbonated (soft) drinks****Water****Sport drinks****Fresh fruit juices****Plain milk****Syrup drinks**

Read this drink label and guess how much sugar is in this drink.

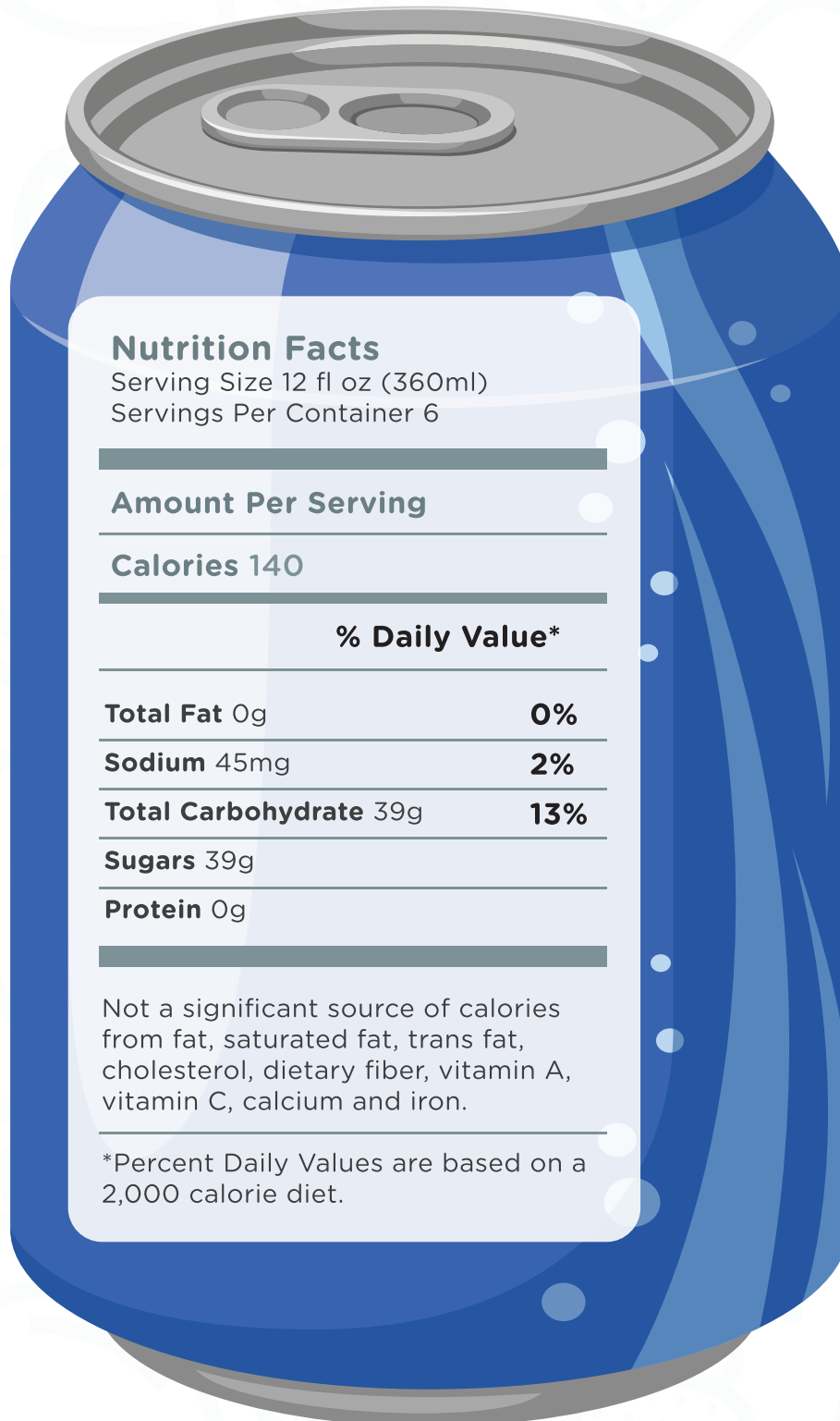

Nutrition Facts

Serving Size 12 fl oz (360ml)
 Servings Per Container 6

Amount Per Serving

Calories 140

% Daily Value*

Total Fat 0g	0%
Sodium 45mg	2%
Total Carbohydrate 39g	13%
Sugars 39g	
Protein 0g	

Not a significant source of calories from fat, saturated fat, trans fat, cholesterol, dietary fiber, vitamin A, vitamin C, calcium and iron.

*Percent Daily Values are based on a 2,000 calorie diet.

How much sugar is in your drinks?

Teacher to take one drink at a time and weigh the sugar according to the drink label. Allow children to guess how much sugar is in these drinks.



Water



Plain Milk



Carbonated Drink



Fruit Juice









Name: _____

Class: _____

Date: _____

Our Findings

<p>Ask a Question</p> 	
<p>Make a Prediction</p> 	
<p>Make a Plan and Follow it</p> 	
<p>Observe</p> 	
<p>Record the Results</p> 	
<p>Draw a Conclusion</p> 	



Note to Parents

Parents serve as children's first teachers and role models. Research has shown that children do better when their parents are engaged in their child's learning journey. It is critical for parents to share the responsibility of instilling in their child positive learning attitudes and values. Help us to help them make healthy lifestyle choices from young!

You can work together with your child's preschool to extend his/her learning and development at home. Having conversations on food and nutrition during mealtimes can encourage your child to cultivate healthy eating habits, while engaging in a simple activity together, such as preparing a meal, helps to reinforce their knowledge.

Here are some ways in which you can partner with your child's preschool:

1. Share your child's healthy eating habits with his/her teacher.
2. Offer your assistance in conducting an interesting take-home activity such as sandwich-making with the children in your child's class.
3. Share your successes or ideas on the parents' bulletin board.



Make a paper lunchbox filled with a balanced meal, including wholegrains! Share your lunchbox with the rest of the class, elaborating on the wholegrain you have chosen and why.



Instructions:

- 1) Cut along the bold lines
- 2) Fold along the dotted lines



